

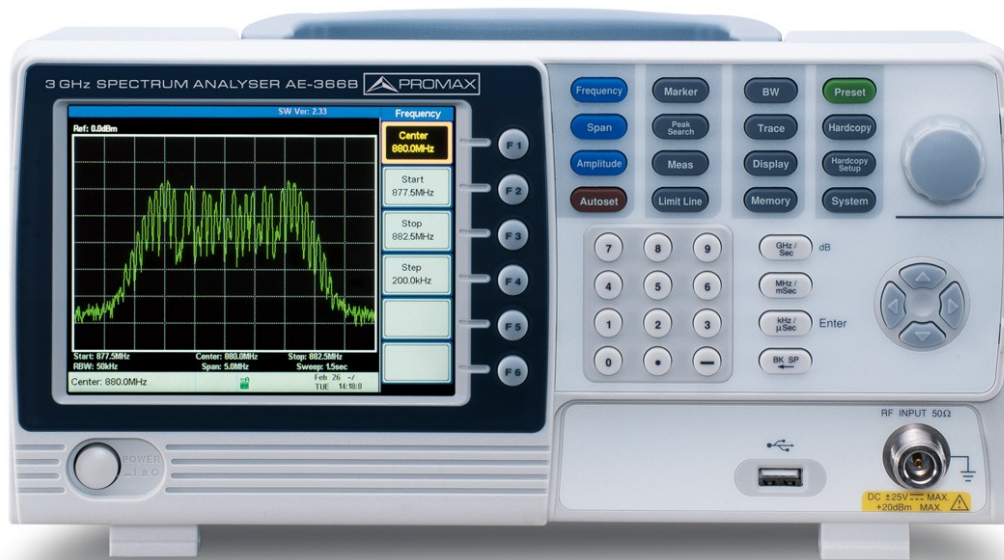

AE-366B

SPECTRUM ANALYSER



MULTIMEDIA CONTENT

You can access instantly to any chapter by clicking on the title of the chapter in the table of contents.

Click on the arrow  at the top right of the page to return to the table of contents.

USER'S MANUAL VERSION

Version	Date	Software Version
1.2	July 2018	1.09 14.04.01

SAFETY RULES

This chapter contains important safety instructions that you must follow during operation and storage. Read the following before any operation to insure your safety and to keep the instrument in the best possible condition.

Safety Guideline

- **General**

- * Do not place any heavy object on the instrument.
- * Avoid severe impact or rough handling that leads to damaging the instrument.
- * Do not discharge static electricity to the instrument.
- * Use only mating connectors, not bare wires, for the terminals.
- * Ensure signals to the RF input do not exceed +30dBm/±25V DC.
- * Do not block the cooling fan opening.
- * Do not disassemble the instrument unless you are qualified.
- * (Measurement categories) EN 61010-1:2010 specifies the measurement categories and their requirements as follows. The instrument falls under category II.

- **Power Supply**

- * AC Input voltage range: 100V~240V.
- * Frequency: 50/60Hz.
- * To avoid electrical shock connect the protective grounding conductor of the AC power cord to an earth ground.

- **Cleaning**

- * Disconnect the power cord before cleaning.
- * Use a soft cloth dampened in a solution of mild detergent and water. Do not spray any liquid.
- * Do not use chemicals containing harsh material such as benzene, toluene and acetone.

- **Operation Environment**

- * Location: Indoor, no direct sunlight, dust free, almost non-conductive pollution (Note below).

- * Temperature: 5 °C to 45 °C.
- * Humidity: 90 % to 45 °C.
- * (Pollution Degree) EN 61010-1:2010 specifies the pollution degrees and their requirement as follows. The instrument falls degree II.















- **Storage environment**

- * Location: Indoor.
- * Temperature: 90 % to 45 °C.

- **Disposal**

- * Do not dispose this instrument as unsorted municipal waste. Please use a separate collection facility or contact the supplier from which this instrument was purchased. Please make sure discarded electrical waste is properly recycled to reduce environmental impact.

- **Symbols related with safety:**

	DIRECT CURRENT		ON (Supply)
	ALTERNATING CURRENT		OFF (Supply)
	DIRECT AND ALTERNATING		DOUBLE INSULATION (Class II protection)
	GROUND TERMINAL		CAUTION (Risk of electric shock)
	PROTECTIVE CONDUCTOR		CAUTION REFER TO MANUAL
	FRAME TERMINAL		FUSE
	EQUIPOTENTIALITY		EQUIPMENT OR COMPONENT TO BE RECYCLED
			

- **Descriptive Examples of Over-Voltage Categories**

Cat I Low voltage installations isolated from the mains.

Cat II Portable domestic installations.

Cat III Fixed domestic installations.

Cat IV Industrial installations.

TABLE OF CONTENTS

1 INTRODUCTION	1-1
1.1 Description	1-1
1.2 Main Features	1-1
1.3 Package Content	1-2
2 GETTING STARTED	2-3
2.1 Appearance	2-3
2.2 First Time Use Instructions	2-8
2.2.1 Tilting the Stand	2-8
2.2.2 Power UP and Down	2-9
2.2.3 Software Update	2-9
2.2.4 USB Driver Installation	2-10
2.3 Restoring Default Settings	2-11
2.4 Conventions	2-12
3 BASIC OPERATION	3-15
3.1 Frequency Settings	3-15
3.1.1 Center Frequency	3-15
3.1.2 Start and Stop Frequency	3-15
3.1.3 Center Frequency Step	3-16
3.2 Span Settings	3-18
3.2.1 Span	3-18
3.2.2 Full Span	3-18
3.2.3 Zero Span	3-19
3.2.4 Last Span	3-19
3.3 Amplitude Settings	3-20
3.3.1 Reference Level	3-20
3.3.2 Amplitude Units	3-21
3.3.3 Scale/Div	3-21
3.4 Autoset	3-22
3.4.1 Using Autoset	3-22
3.4.2 Limiting the Autoset Vertical Search Range	3-23
3.4.3 Limiting the Autoset Horizontal Search Range	3-23
3.5 Marker	3-24
3.5.1 Activating a Marker	3-25
3.5.1.1 Activate a Normal Marker	3-25
3.5.1.2 Activate a Delta Marker	3-26
3.5.1.3 Move Marker Manually	3-27
3.5.1.4 Move Marker to Preset Locations	3-27
3.5.2 Move marker to Trace	3-28
3.5.2.1 Turn All Markers On or Off	3-29
3.5.3 Show Markers in Table	3-29
3.5.3.1 Edit Markers in Marker Table	3-30
3.5.4 Peak Search	3-31
3.5.4.1 Move Marker to Peak	3-31
3.5.4.2 Move Marker and Peak to Center	3-31
3.5.4.3 Search for Peaks	3-32

3.5.5	Peak Table	3-33
3.6	Measurement	3-35
3.6.1	Channel Analysis Overview	3-35
3.6.1.1	ACPR	3-36
3.6.1.2	OCBW	3-39
3.7	Limit Line Testing	3-41
3.7.1	Activate a Limit Line	3-41
3.7.2	Creating a Limit (Point by Point)	3-42
3.7.2.1	Pass/Fail Testing	3-43
3.8	Bandwidth	3-45
3.8.1	Resolution Bandwidth Setting (RBW)	3-45
3.9	Trace	3-46
3.9.1	Selecting a Trace	3-46
3.9.2	Trace Math	3-48
3.9.3	Average Trace	3-48
3.10	Display	3-50
3.10.1	Adjusting the LCD Brightness	3-50
3.10.2	Setting a Display Line (Reference Level Line)	3-50
3.10.3	Using the Video Out Port	3-51
3.10.4	Split Spectrum View	3-51
3.11	Save/Recall Files	3-53
3.11.1	Save/Recall Setup	3-53
3.11.2	Save/Recall Trace Data	3-54
3.11.3	Save/Recall Limit Lines	3-55
3.11.4	Saving an Image File (Hardcopy)	3-55
3.11.5	Hardcopy Setup	3-56
3.11.6	Load Default Settings	3-56
3.12	System Settings	3-57
3.12.1	System Information	3-57
3.12.2	System Language	3-58
4	REMOTE CONTROL	4-59
4.1	Interface Configuration	4-59
4.1.1	Configure Remote Interface	4-59
4.1.2	Remote Control Function Check	4-60
4.2	Command Syntax	4-61
4.3	Command List	4-63
4.3.1	IEEE488.2 Standard Commands	4-63
4.3.2	Sweep Commands	4-63
4.3.3	Frequency Commands	4-63
4.3.4	Span Commands	4-64
4.3.5	Amplitude Commands	4-65
4.3.6	Marker and Peak Search Commands	4-65
4.3.7	Trace Commands	4-68
4.3.8	Power Measurement Commands	4-69
4.3.9	Limit Line Commands	4-71

4.3.10	BW Commands	4-71
4.3.11	Display Commands	4-72
4.3.12	Preset Commands	4-73
4.3.13	System Commands	4-73
5	FAQ	5-74
6	SPECIFICATIONS	6-75
6.1	Specifications AE-366B	6-75
6.2	Default Settings	6-77



SPECTRUM ANALYSER

AE-366B

1 INTRODUCTION

1.1 Description

The **AE-366B** is a low-cost, basic spectrum analyzer. The **AE-366B** has all the basic features of our more advanced models, but in a smaller package, designed especially for education.

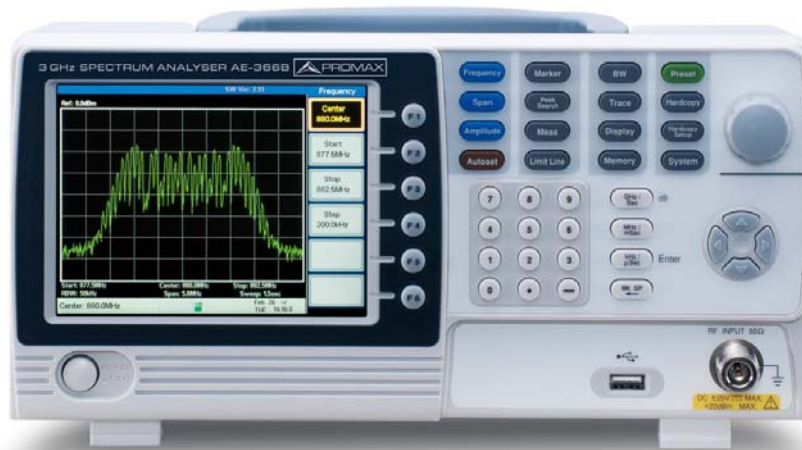

Figure 1.

1.2 Main Features

► Performance:

- 150 kHz ~ 3 GHz.
- 100 kHz resolution.

► Features:

- Autoseg with automatic floor level and span.
- Marker table function.
- Limit line testing.
- Split window display.



- ACPR measurement.
- OCBW measurement.
- Automatic resolution bandwidth mode.

► **Interface:**

- 480 × 640 color LCD display.
- On-screen menu icons.
- VGA video output.
- RS-232C.
- USB 2.0 Host port for data storage.
- USB 2.0 Device port for the virtual com port communication.

1.3 Package Content

Opening the box

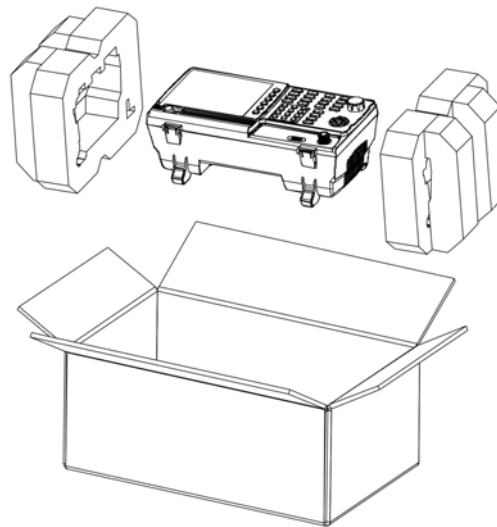

Figure 2.

Check that your package contains the following elements:

- **AE-366B** Analyser.
- Quick Start Guide.
- Mains cord for external DC charger.



2 GETTING STARTED

2.1 Appearance

■ Front Panel

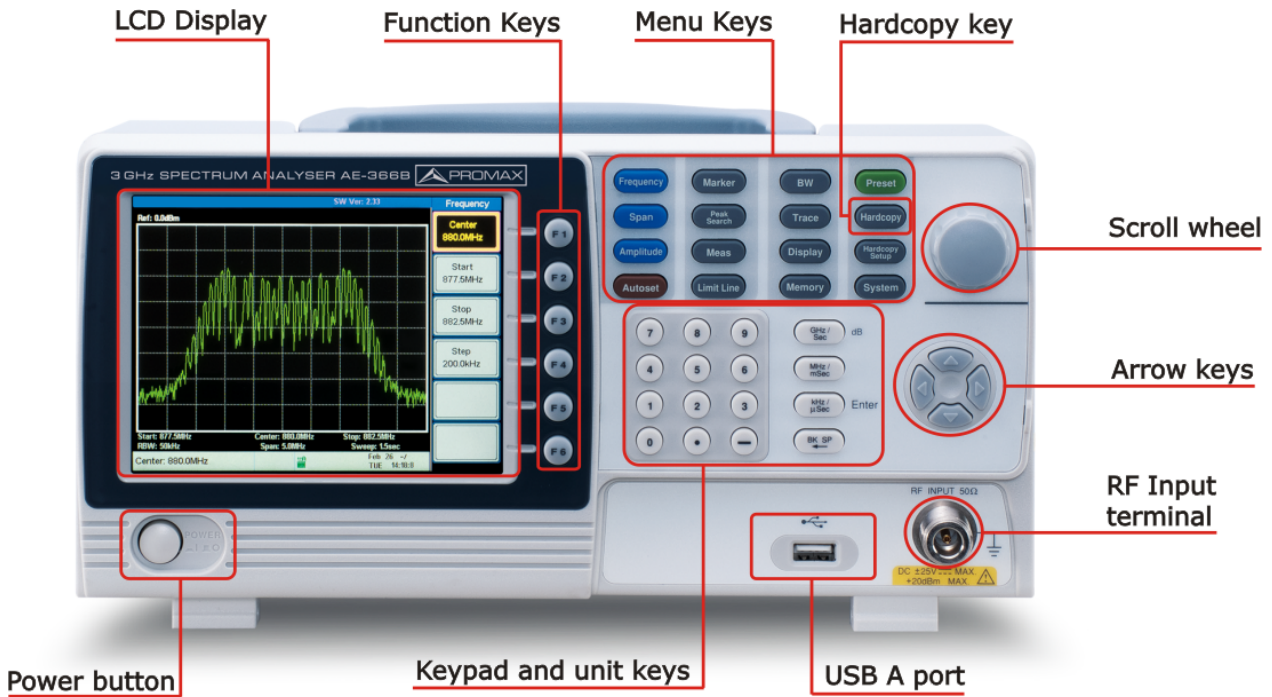

Figure 3.

► LCD display:

640 X 480 color LCD display. The display shows the soft keys for the current function, frequency, amplitude and marker information.

► Function keys:

The **F1** to **F6** function keys directly correspond to the soft keys on the right-hand side of display.

► Menu keys:

■ Frequency:

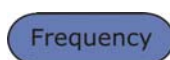

Sets the center frequency, start frequency, stop frequency and step frequency.

■ Span:



Sets the span, with options for full span, zero span and last span.



- Amplitude:**
Amplitude
Sets the amplitude reference level, scale and amplitude units.
- Autoset:**
Autoset
Automatically searches the peak signal with maximum amplitude and displays it with appropriate horizontal and vertical scales.
- Marker:**
Marker
The Marker key is used to configure the markers, trace markers as well as other related functionality.
- Peak Search:**
Peak Search
Finds each maximum and minimum peak. Used with the Marker functions.
- Meas:**
Meas
Configures ACPR and OCBW measurements.
- Limit Line:**
Limit Line
Sets and tests Pass/Fail limit lines.
- BW:**
BW
Sets the resolution bandwidth.
- Trace:**
Trace
Sets traces and trace related functions.
- Display:**
Display
The Display key configures the split-screen windowing mode and the basic display properties.
- Memory:**
Memory
The memory key is used to save or recall setup, trace and limit line data.
- Preset:**
Preset
The Preset key will restore the spectrum analyzer to the factory settings.
- Hardcopy:**
Hardcopy
The hardcopy key is a quick save key that will save a screen-shot of the display.
- Hardcopy setup:**
Hardcopy Setup
Configures the hardcopy options.
- System:**
System
The System key is used to configure the RS232 interface, language, update the firmware as well as other system options.



► **Power key:**



Turns the instrument on/off.

► **Scroll wheel:**

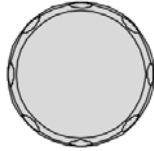

Edit values, select listed items.

► **Arrow keys:**

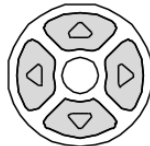

Increment/decrement values (in steps), select listed items.

► **RF input terminal:**

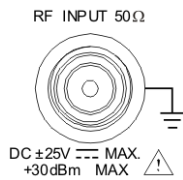

RF input port. Accepts RF inputs.

- **Maximum input:** +30 dBm (+20 dBm measurable).
- **Input impedance:** 50 Ω.
- **Maximum DC voltage:** ±25 V.
- **N-type:** female.

► **Numeric keypad:**



The numeric keypad is used to enter values and parameters. It is often used in conjunction with the arrow keys and scroll wheel.



■ Rear Panel

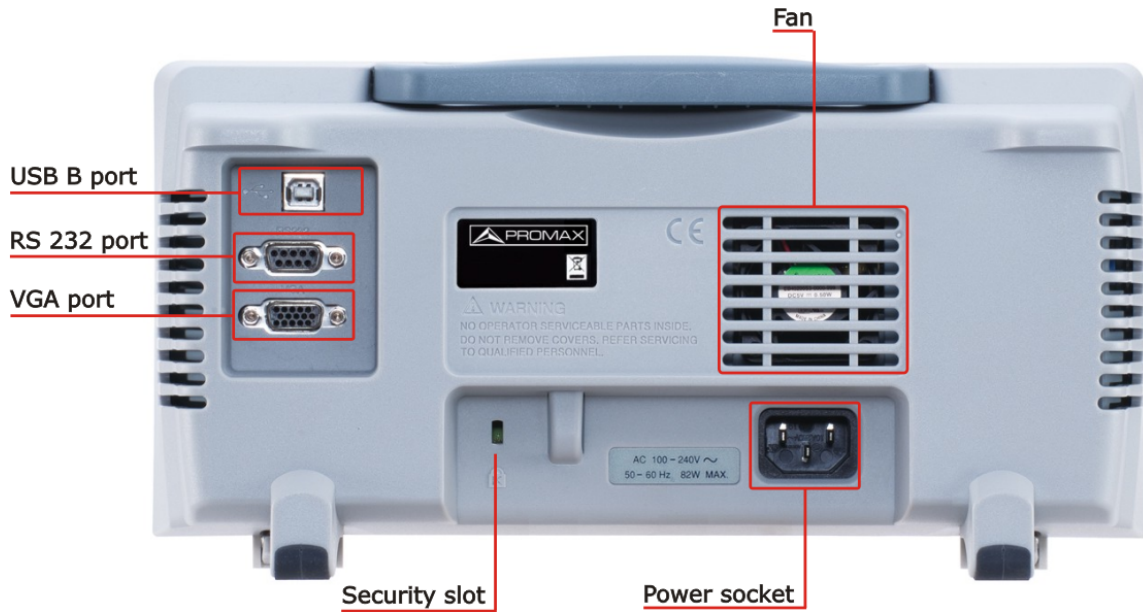
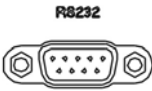
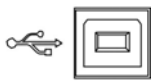





Figure 4.

- ▶ **RS-232:**  RS232 9 pin DSUB port.
- ▶ **USB B:**  USB B Device port. USB 1.1/2.0.
- ▶ **VGA:**  VGA video-out port. Supports SVGA (480X640).
- ▶ **Power Socket:**  Power Socket: 100~240V, 50/60Hz. 15W Max.
- ▶ **Security Slot:**  Kensington-type security slot.



■ Display

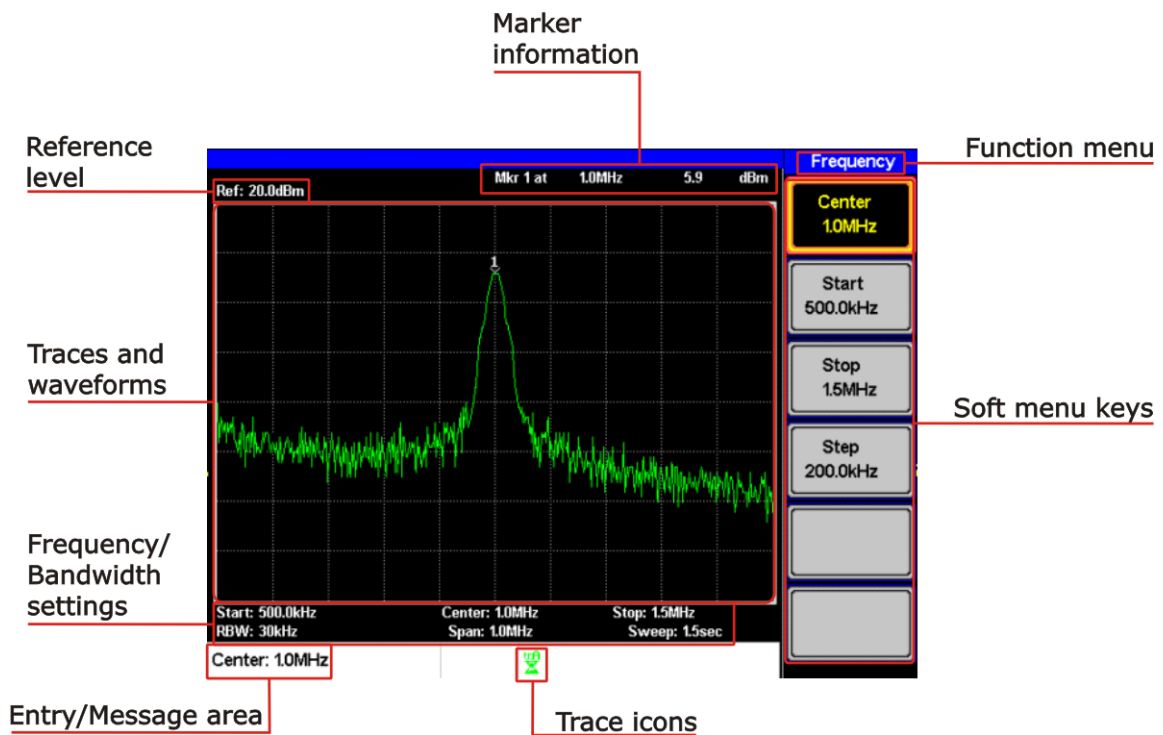

Figure 5.

- ▶ **Reference level:**
Displays the reference level.
- ▶ **Marker Information:**
Displays marker information.
- ▶ **Function menu:**
Displays the current function menu.
- ▶ **Soft menu keys:**
The Soft menu keys are associated with the F1 to F6 function keys to the right of the display.
- ▶ **Trace Icons:**
Displays the color of each active trace and the trace mode of each active trace.
- ▶ **Entry/Message area:**
This area is used to show system messages, errors and input values/parameters.
- ▶ **Frequency/Bandwidth settings:**
Displays the Start, Center and Stop frequencies, RBW, Span and Sweep settings.



► **Trace and waveforms:**

Main display showing the traces, limit lines and marker positions.

2.2 First Time Use Instructions

Use the procedures below when first using the **AE-366B** to tilt the stand, power up the instrument, update the firmware and restore the unit back to the default settings. Lastly, the Conventions sections will introduce you to the basic operating conventions used throughout the user manual.

2.2.1 Tilting the Stand

The **AE-366B** has two adjustable tabs at the front that can be used to position the instrument into two preset orientations.

► **Leaning Position:**

Set the tabs down to have the **AE-366B** leaning backward.

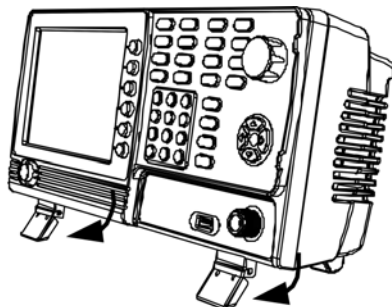

Figure 6.

► **Upright Position:**

Set the tabs flat to have the **AE-366B** in an upright position.

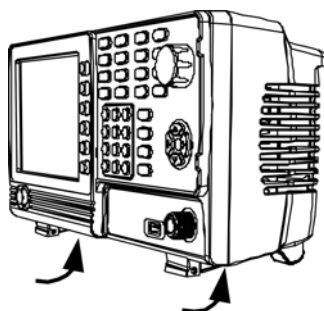

Figure 7.



2.2.2 Power UP and Down

► **Power UP:**

- 1 Insert the AC power cord into the power socket.

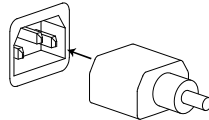

Figure 8.

- 2 Press the power button to turn the **AE-366B** on.

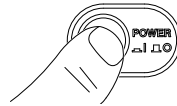

Figure 9.

- 3 The **AE-366B** will begin to boot up in under a few seconds.

 **NOTE:** If system fails to start, please see your local PROMAX distributor.

► **Power Down:**

- 1 Press the power button to power down.



Figure 10.

2.2.3 Software Update

The **AE-366B** allows the software to be updated by end-users. Before using the **AE-366B**, please check the PROMAX website or ask your local distributor for the latest software.

The update file, MAIN1.BIN, must be placed in the root directory of a USB flash drive.

► **System version:**

Before updating the software, please check the software version.

- 1 Press  ► *Information* .



- 2 The system version is displayed on the SW Ver  icon.

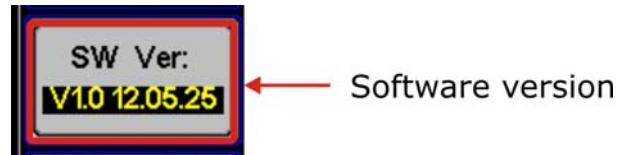
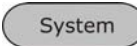



Figure 11.

► Update software:

Before updating the software, please check the software version.

- 1 Place the update file, MAIN1.BIN, into the root directory of a USB flash drive.
- 2 Insert the USB flash drive into the USB port on the front panel.
- 3 Press  ► *Update From USB Flash* .
- 4 Press *Update Now*  to execute the update process.
When the message "Programmed Successful" is displayed, the software has successfully completed the update procedure.
- 5 Reboot the system when the update procedure has finished by cycling the power button.
- 6 Check the software version again to confirm the update procedure.

 **NOTE:** The upgrade process may take a few minutes.

2.2.4 **USB Driver Installation**

If the type B USB port on the rear panel is to be used for remote control, then the USB driver must be installed.

- 1 Ensure the **AE-366B** is turned on.
- 2 Connect the USB cable from the PC to the rear panel USB B port.
- 3 Windows will automatically detect the **AE-366B** as a new device.



- 4 Follow the instructions to locate the **AE-366B** driver.
- 5 To see if the driver has been successfully installed, you can check to see if the **AE-366B** is recognized by the Windows Device Manager when the **AE-366B** is connected to the PC.

In Windows XP go to: Start ► Control Panel ► Device Manager.

The **AE-366B** should be shown under the Ports (COM & LPT) node:



Figure 12.

 **NOTE:** If the USB driver installation fails, you can try to manually install the driver.

You can tell that the driver hasn't been installed if you see the USBSerial icon in the ports node.

Right clicking this icon will allow you to manually install the AE-366B.ini driver.

2.3 Restoring Default Settings

The factory default settings can be easily restored using the **Preset** key on the front panel. The default settings cannot be changed.

- 1 Press .

(The spectrum analyzer will load the default factory settings).



2.4 Conventions

The following conventions are used throughout the user manual. Read the conventions below for a basic grasp of how to operate the AE-366B menu system and front panel keys.

► Soft Menu keys:

The F1 to F6 function keys on the right side of the display correspond directly to the soft-menu keys on their left.

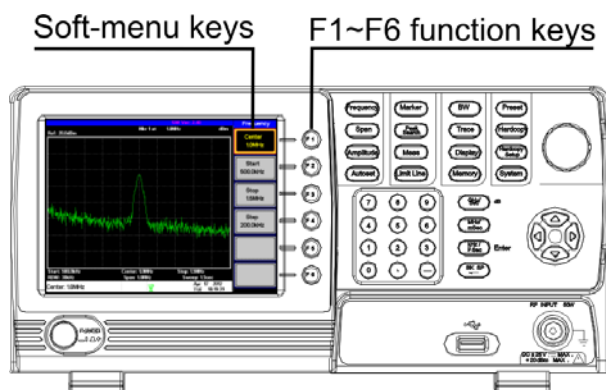

Figure 13.

► Input Parameter Values:



Selecting this type of menu key will allow you to enter a new value with the numeric keypad or increment/decrement the value using the scroll wheel or number pad. See the parameter input description below for more details.

► Toggle State:



Pressing this menu key will toggle the state. Notice that any soft-menu key that can be toggled will have the active parameter underlined.

► Toggle State & Input Parameter:



Pressing this menu key will allow you to toggle the state of the function between on and off. When in the on-state, the parameter value can be manually edited. Use the numeric keypad to enter the new value or use the scroll wheel to increment/decrement the current value. Again, the setting that is underlined is the active setting.

► Sub Menu:



Pressing the *More* menu key will enter a submenu.

► Sub Menu to select parameter:



Pressing this type of menu key will enter a submenu to select a parameter.



▶ **Return to the Start of a Menu Tree:**

When you have navigated down a menu tree and you wish to return to the start of the menu tree, simply press the same Menu again.

For example if you pressed:

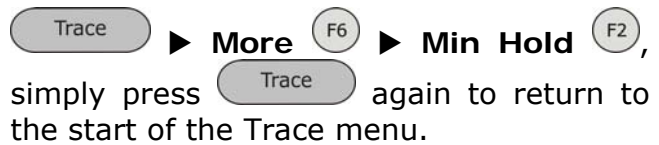

▶ **Active Function:**



Pressing this type of menu key will activate that function. The menu key will be highlighted to show it is the active function.

▶ **Parameter input:**

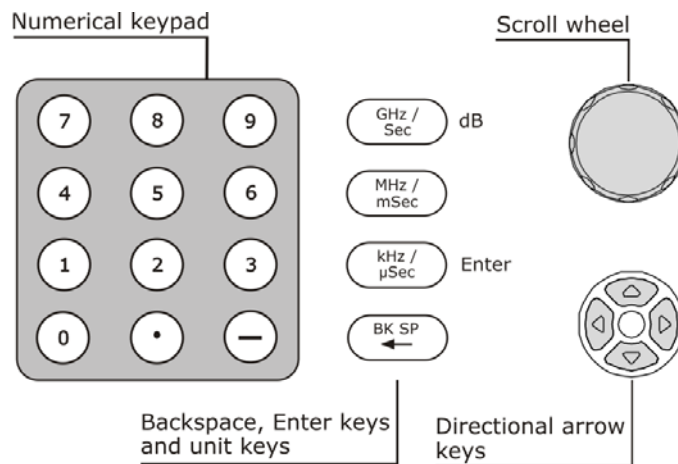

Figure 14.

Parameter values can be entered using the numeric keypad, the scroll wheel and the arrow keys.

■ **Using the numeric keypad:**

When prompted to enter a parameter, use the number keys (0 ~ 9), the decimal key (.) and the minus key (-) to enter a value. After a value has been entered, the unit keys can be used to select the units.



The value of the parameter is shown at the bottom of the screen as it is edited.

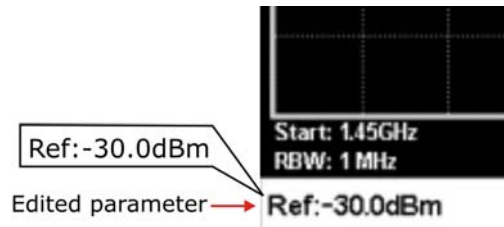

Figure 15.

- **Back Space:**
Use the backspace key to delete the last character or number entered.
- **Using the scroll wheel:**
Use the scroll wheel to alter the current value. Clockwise increases the value, anti-clockwise decreases the value. The scroll wheel is usually used for values that highly variable, such as the center frequency settings.
- **Directional arrows:**
Use the directional arrows to select discrete parameters or to alter values by a coarser resolution than the scroll wheel. Left/down decreases the value, right/up increases the value. The directional arrows are usually used for values that are of a discrete nature, such as selecting a memory location.



3 BASIC OPERATION

3.1 Frequency Settings

3.1.1 Center Frequency

The center frequency function sets the center frequency and centers the display to the center frequency.

- 1 Press **Frequency** ► **Center** (F1) and enter the frequency and unit.

Range 0 kHz ~ 3 GHz

Default: 1.5 GHz.

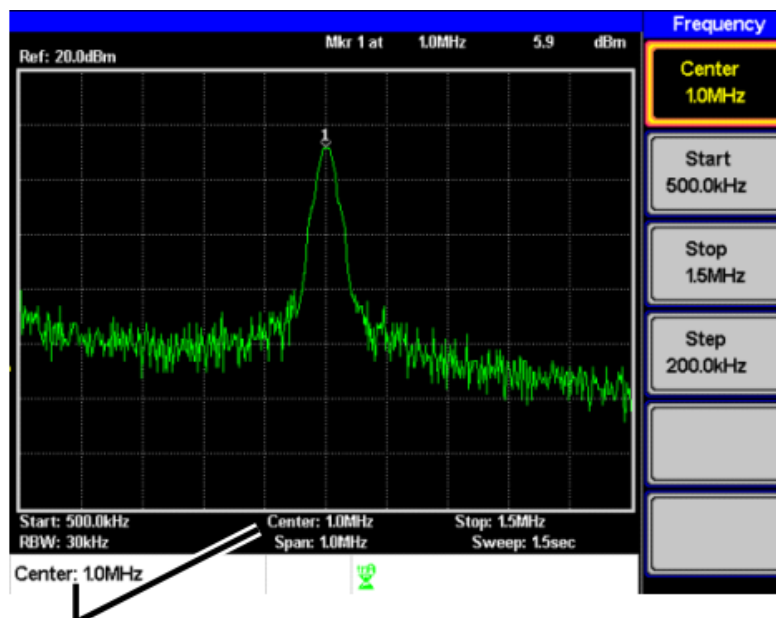

Set center frequency

Figure 16.

3.1.2 Start and Stop Frequency

The start/stop frequency function will set the start and stop frequency of the span.

- 1 To set the start frequency, press **Frequency** ► **Start** (F2) and enter the frequency and unit.



- 2 To set the stop frequency, press **Frequency** ► **Stop** (F3) and enter the frequency and unit.

Range: 0 kHz ~ 3 GHz.

Default Start frequency: 0 Hz.

Default Stop frequency: 3 GHz.

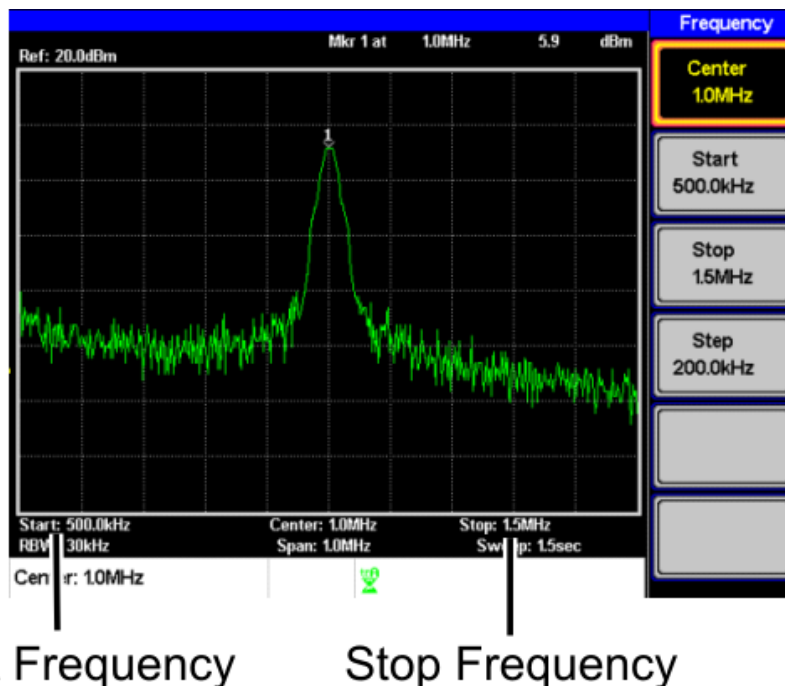

Figure 17.

NOTE: The start and stop frequency can change when the span settings are used. The stop frequency must be set higher than the start frequency (for spans ≠ 0).

3.1.3 Center Frequency Step

The Step function sets the step size of the center frequency when using the arrow keys.

When the arrow keys are used to alter the center frequency, each press will move the center frequency by the step size specified by the **Step** function.



By default, the center frequency step size is equal to 10% of the span.

- 1 Press **Frequency** ► **Step** (F4) and set the center frequency step size.
Range: 1 kHz ~ 3 GHz.

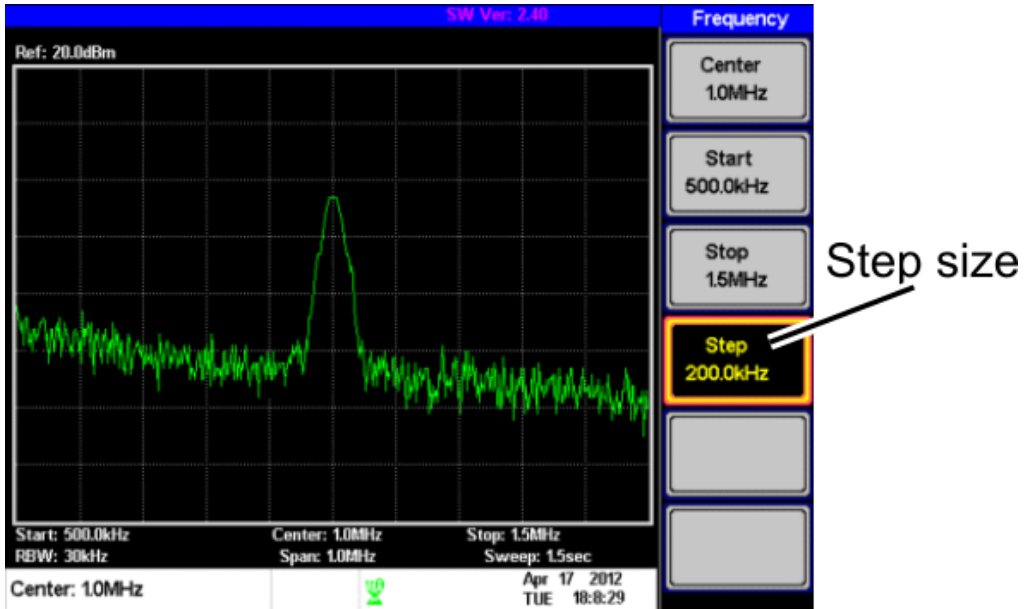

Figure 18.



3.2 Span Settings

3.2.1 Span

The Span function will set the frequency range of the sweep. The sweep will be centered around the center frequency.

Setting the span will alter the start and stop frequencies.

- 1 Press **Span** ► **Span** (F1) and enter the span frequency range and unit.

Range: 0 kHz ~ 3 GHz.

Default Span: 3 GHz.

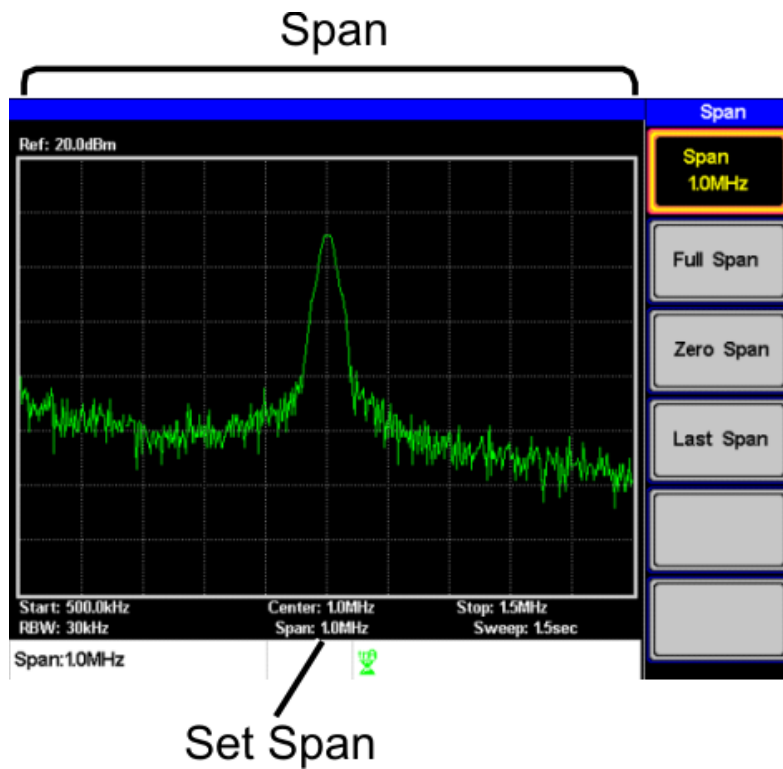

Figure 19.

3.2.2 Full Span

The Full Span function will set the span to the full frequency range.

This function will set the start and stop frequencies to 0 Hz and 3 GHz respectively.

- 1 Press **Span** ► **Full Span** (F2).



3.2.3 Zero Span

The Zero Span function will set the frequency range of the sweep to 0 Hz and fixes the start and stop frequencies to the center frequency.

The Zero Span function measures the time domain characteristics of the input signal at the center frequency. The horizontal axis is displayed in the time domain.

- 1 Press **Span** ► **Zero Span** (F3).

The span changes accordingly.

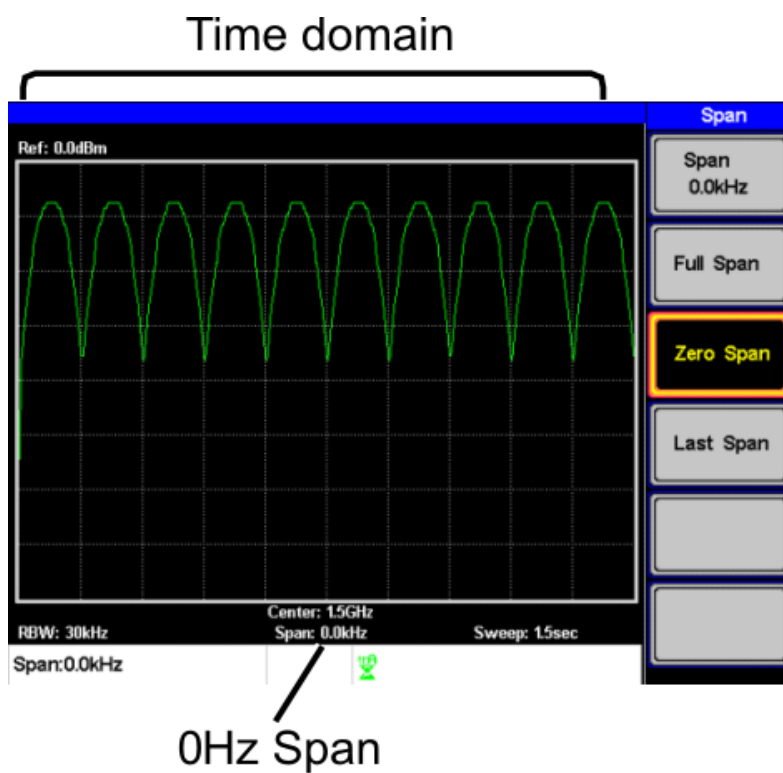

Figure 20. Amplitude modulation.

NOTE: The measurement functions such as ACPR and OCBW are not available with the zero span setting.

3.2.4 Last Span

The last span function returns the spectrum analyzer to the previous span settings.

- 1 Press **Span** ► **Last Span** (F4).



3.3 Amplitude Settings

The vertical display scale is defined by the reference level amplitude, attenuation, scale and external gain/loss.

3.3.1 Reference Level

The reference level defines the absolute level of the amplitude on the top graticule in voltage or power.

- 1 Press **Amplitude** ► **Ref. Level** (F1) and enter the reference level amplitude.

Range: -20dBm ~ 20dBm.

Resolution: 10 dBm.

Ref Level reading

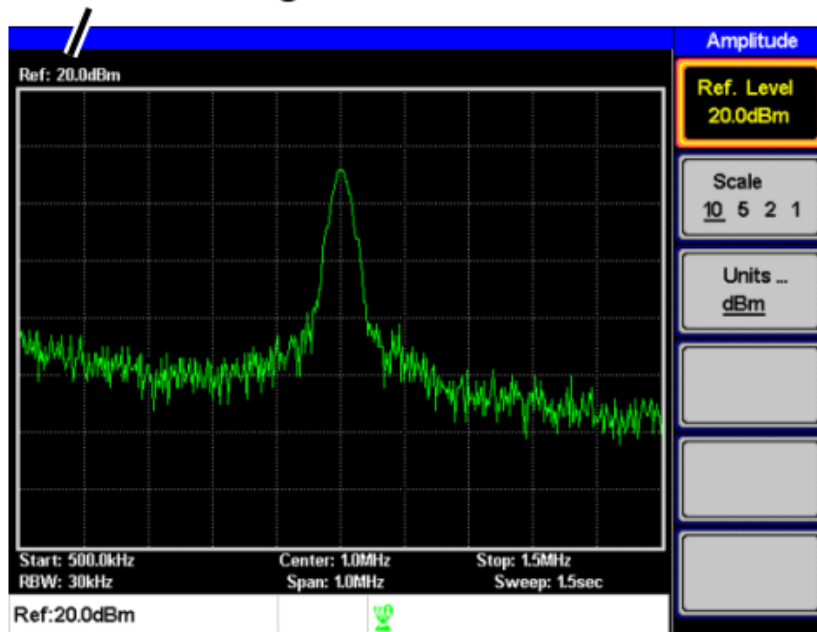

Figure 21.



3.3.2 Amplitude Units

The amplitude units can be set from dBm, dBmV or dBuV.

- 1 Press **Amplitude** ► **Units...** (F3) to change the amplitude units.
Units: dBm, dBmV, dBuV.

3.3.3 Scale/Div

Sets the logarithmic units for the vertical divisions.

- 1 Press **Amplitude** ► **Scale** (F2) repeatedly to select the vertical division units.
Scale Range: 10, 5, 2, 1.

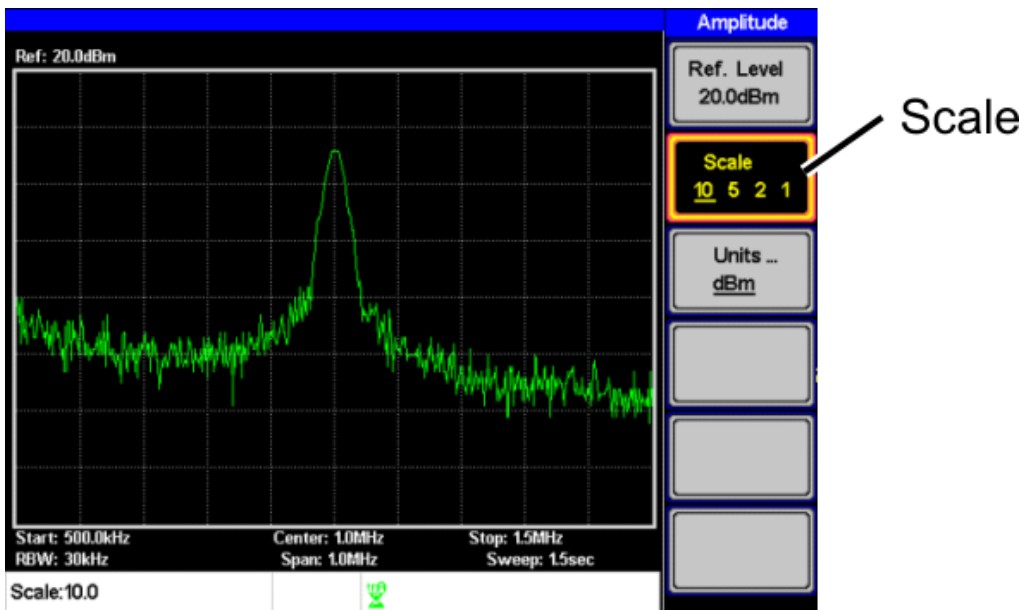

Figure 22.



3.4 Autoset

The Autoset function searches the peak signals and picks the signal peak with the maximum amplitude, and then shows it in the display.

3.4.1 Using Autoset

- 1 Press **Autoset** **Autoset** (F1).

Amplitude: Over the full amplitude range.

Span: Over the full span range.

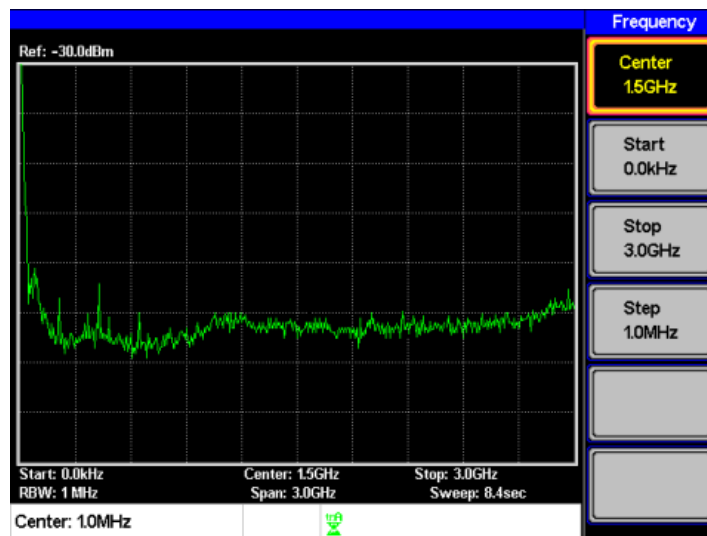

Figure 23. Before Autoset, default state.

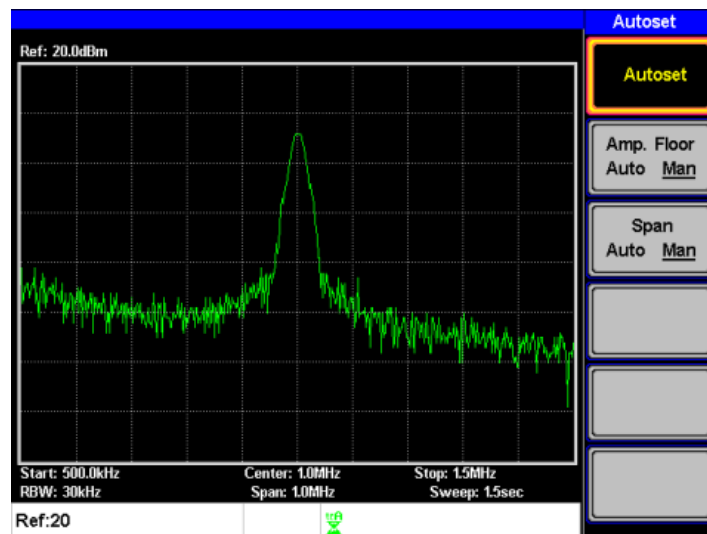



Figure 24. After Autoset.

NOTE: RBW setting is reset to Auto when the Autoset function is used.





3.4.2 Limiting the Autoset Vertical Search Range

You can set the amplitude floor so that the signals lower than the setting will be ignored by the Autoset search.

- 1 Press  ► **Amp.Floor**  and switch the range from Auto to Man.
- 2 Enter the amplitude limit with the number pad and Enter key.
Range: -50 to + 20 dBm.

3.4.3 Limiting the Autoset Horizontal Search Range

You can change the frequency span limit in the display to get a better view of the Autoset result. By default, the frequency span after Autoset is set at 3 MHz.

- 1 Press  ► **Span**  and switch the range from Auto to Man.
- 2 Enter the span frequency for the Autoset search.
Manual Range: Full amplitude range.



3.5 Marker

A Marker shows the frequency and amplitude of a waveform point. The **AE-366B** can activate up to 5 markers or marker pairs simultaneously.

The marker table and peak table functions help editing and viewing multiple markers in a single display.

The delta marker function allows you to see the frequency and amplitude differences between reference markers.

The **AE-366B** can automatically move a marker to various locations including the peak signal, center frequency, and start/stop frequency. Other marker operations regarding signal peaks are available in the Peak Search function.

- Activating a Marker
- Activate a Delta Marker
- Move Marker Manually
- Move Marker to Preset Locations
- Move Marker to Trace
- Turn All Markers On or Off
- Show Markers in Table
- Peak Search
- Move Marker to Peak
- Move Marker and Peak to Center
- Search for Peaks
- Peak Table



3.5.1 Activating a Marker

There are two basic marker types, normal markers and delta markers. Normal markers are used to measure the frequency/time or amplitude of a point on the trace. Delta markers are used to measure the difference between a reference point and a selected point on the trace.

3.5.1.1 Activate a Normal Marker

- 1 Press **Marker** ► **Marker** (F1) and select a marker number.
Marker: 1 ~ 5.
- 2 Press (F2) to turn the selected marker on.
- 3 Press **Mode** (F3) and set the marker mode to Normal.
- 4 The display will show the marker on the trace (centered by default) with the marker measurement at the top of the display.

Marker No, Frequency, Amplitude

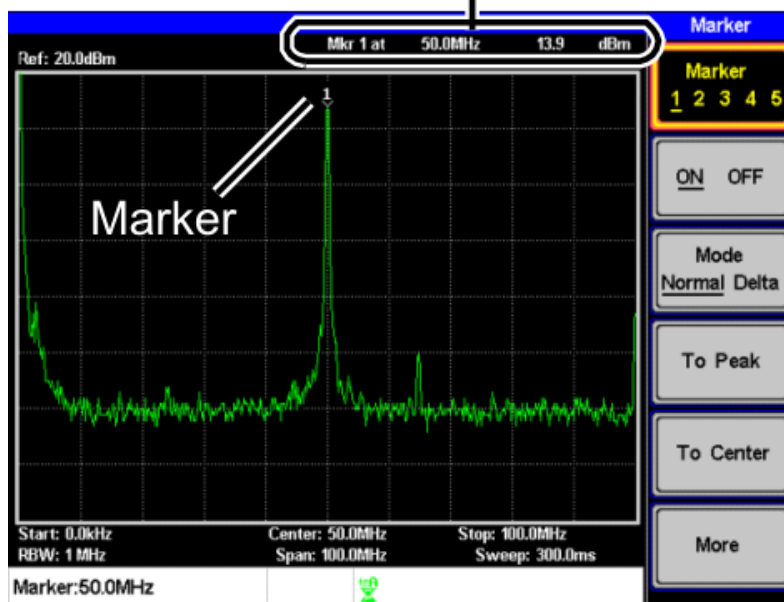

Figure 25.



3.5.1.2 **Activate a Delta Marker**

Delta markers are marker pairs that measure the difference in frequency and amplitude between a reference marker and a delta marker.

When delta markers are activated, the reference and delta marker appear at the position of the selected marker, or in the center of the display if the selected marker has not yet be activated.

The marker measurement is located at the top of the display, under the "normal marker" measurement.

Ref: Reference marker, designated as $\downarrow 1$.

Delta: Delta marker, designated as $\uparrow 1 \downarrow$.

- 1 Press **Marker** \blacktriangleright **Marker** (F1) and select a marker number.
- 2 Press (F2) to turn the selected marker on.
- 3 Press **Mode** (F3) to set the mode to Delta to activate the delta marker.

Delta maker No., Frequency, Amplitude

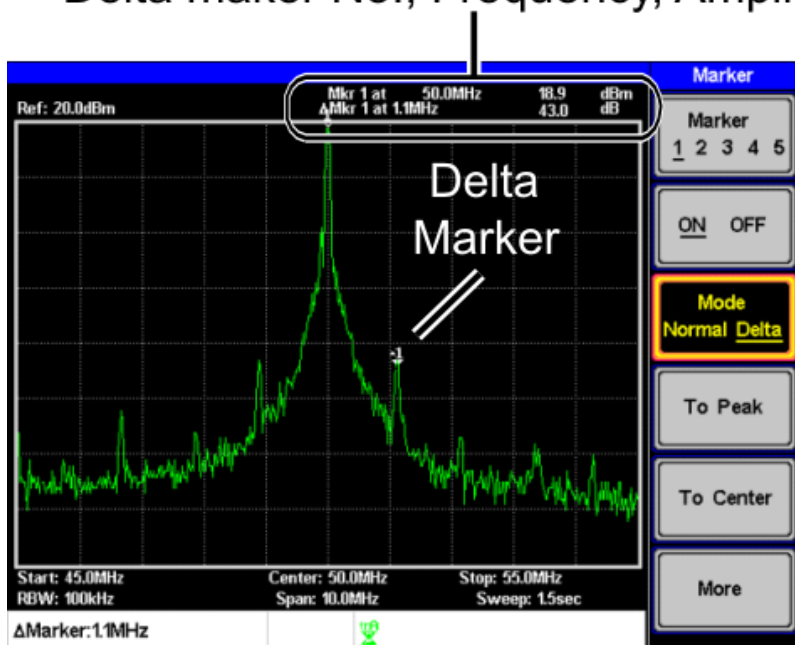

Figure 26.



3.5.1.3 Move Marker Manually

- 1 Press **Marker** ► **Marker** **F1** and select a marker number.
- 2 Use the left/right arrow keys to move the marker one screen division at a time or use the scroll wheel to move the marker in fine increments (one pixel at a time).

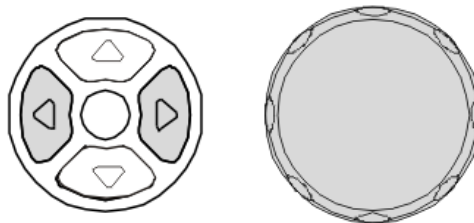

Figure 27.

- 3 Alternatively, the numeric keypad can be used to directly enter the frequency of the marker position.

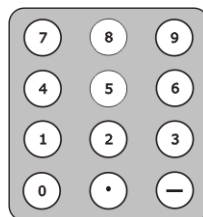

Figure 28.

3.5.1.4 Move Marker to Preset Locations

The currently selected marker (normal marker or delta marker) can be moved to a number of preset positions:

- **Center:** Move to center frequency.
- **Peak:** Move to the highest peak.
- **Start:** Move to start frequency.
- **Stop:** Move to stop frequency.
- **Step:** Move to step frequency.
- **Ref. Level:** Move to reference level amplitude.

NOTE: When a marker is moved to a preset position the span and other settings may be automatically changed.



► **Move marker to peak:**

1 Press **Marker** ► **To Peak** **F4**.

► **Move marker to center:**

1 Press **Marker** ► **To Center** **F5**.

► **Move marker to other positions:**

1 Press **Marker** ► **More** **F6** ► **Marker to...** **F4** and select one of the preset positions:

- **Marker to Start** **F2**.
- **Marker to Stop** **F3**.
- **Marker to Step** **F4**.
- **Marker to Ref. Level** **F5**.

3.5.2 **Move marker to Trace**

The Marker Trace function moves the selected marker to the currently active trace.

- 1 Press **Marker** ► **Marker** **F1** and select a marker number.
- 2 Press **More** **F6** ► **Marker Trace** and select a trace to assign the selected marker to. If **Auto** is selected, the selected marker is automatically assigned a trace.

Marker Trace: Auto, A, B, C.



- 3 In the example below, marker 1 is set to trace B.

Marker1, Trace B

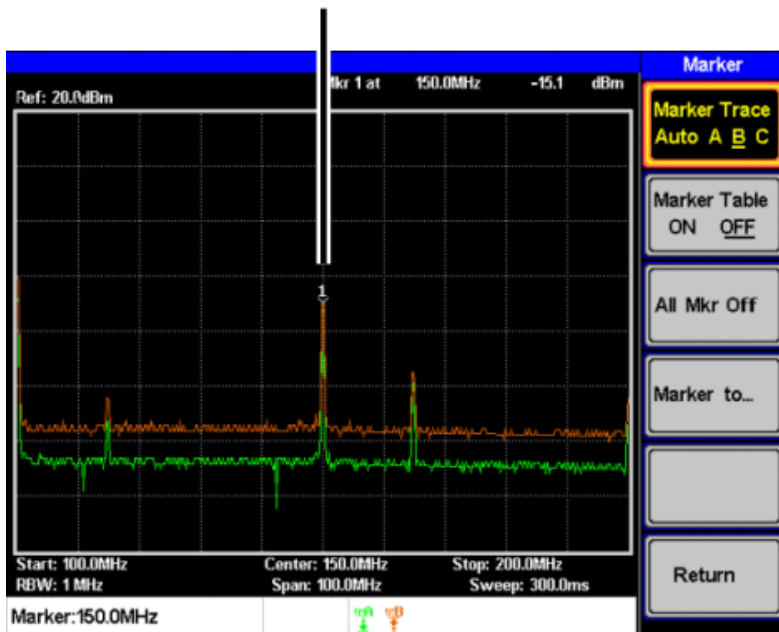

Figure 29.

3.5.2.1 Turn All Markers On or Off

All markers that have been activated, both normal and delta markers, can be turned off at the same time with the All Mrk Off function.

- 1 Press **Marker** ► **More** (F6) ► **All Mrk Off** (F3) and turn all the markers off.

3.5.3 Show Markers in Table

The **AE-366B** has a Marker Table function to show all the active markers and measurements at once.

- 1 Press **Marker** ► **More** (F6) ► **Marker Table** (F2) and turn the marker table on.



- 2 The display will split into two screens. The bottom half will show the Marker Table with the marker No. (normal, reference or delta), frequency and the amplitude of the marker.

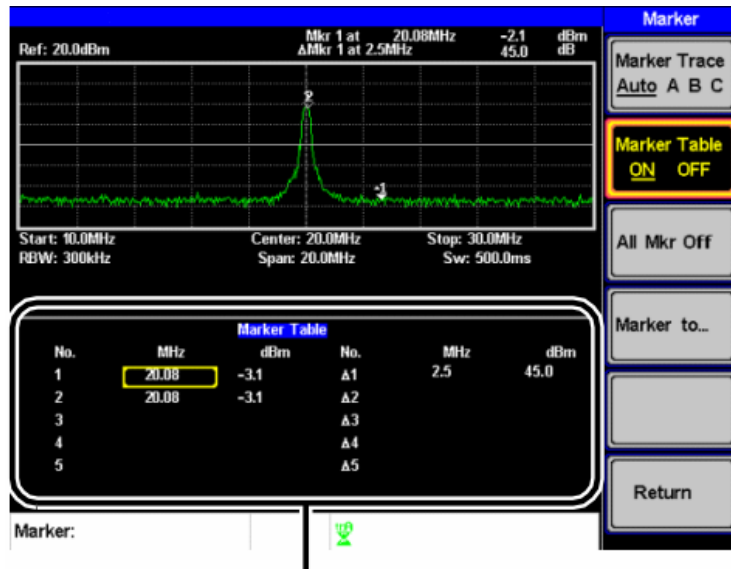

Marker Table
Figure 30.

3.5.3.1 Edit Markers in Marker Table

While the Marker Table function is the active function, the position of each marker and delta marker can be edited within the marker table.

- 1 Use the arrow keys to move the cursor to the frequency column of the desired marker.

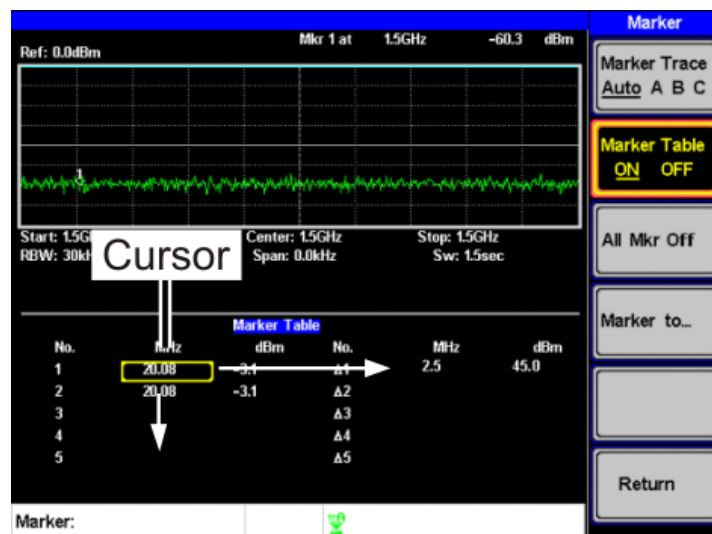

Figure 31.









- 2 Enter the new position of the marker using the keypad and units keys.

3.5.4 Peak Search

The Peak Search key is used to find trace peaks. The currently active marker is used in conjunction with the peak functions to mark the peaks that are found. Peaks can be sorted by frequency or amplitude in the peak table.

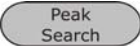
3.5.4.1 Move Marker to Peak

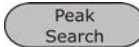
Move the active marker to the highest peak. The highest peak can be either found once or continuously.

- 1 Press  ► **Marker**  and select a marker number.
- 2 Press  ► **Peak Search** .
- 3 To continually search for the peak each sweep, press,  ► **More**  ► **Peak Track**  and set **Peak Track** to ON.

3.5.4.2 Move Marker and Peak to Center

The **Peak to Center** function moves the marker to the highest signal peak and moves the center frequency to that peak.

- 1 Press  ► **Select Marker**  and select a marker number.
- 2 Press  ► **Peak to Center** .



NOTE: The span will not be changed.



3.5.4.3 Search for Peaks

The **Peak Search** key can be used to search for a number of different peaks.

- **Next Peak:** Searches for next highest peak visible on the display.
- **Next Peak Right:** Searches for the next peak to the right of the marker.
- **Next Peak Left:** Searches for the next peak to the left of the marker.
- **Min Search:** Searches for the lowest peak.

1 Press **Marker** ► **Marker** **F1** and select a marker number.

2 Press **Peak Search** and select the type of peak you wish to find.

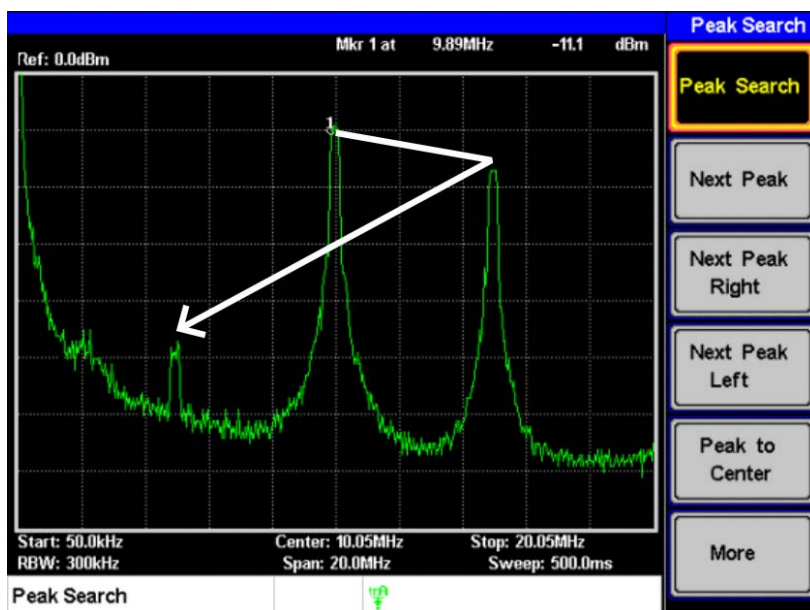

Figure 32. Next Peak.

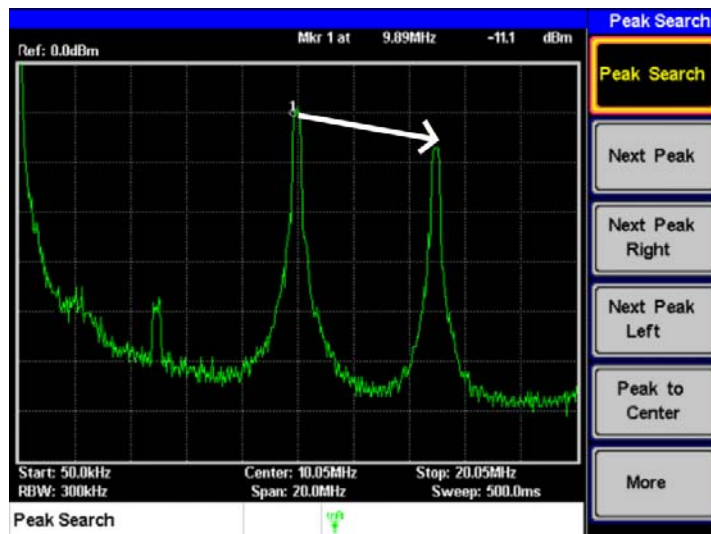

Figure 33. Next Peak Right.

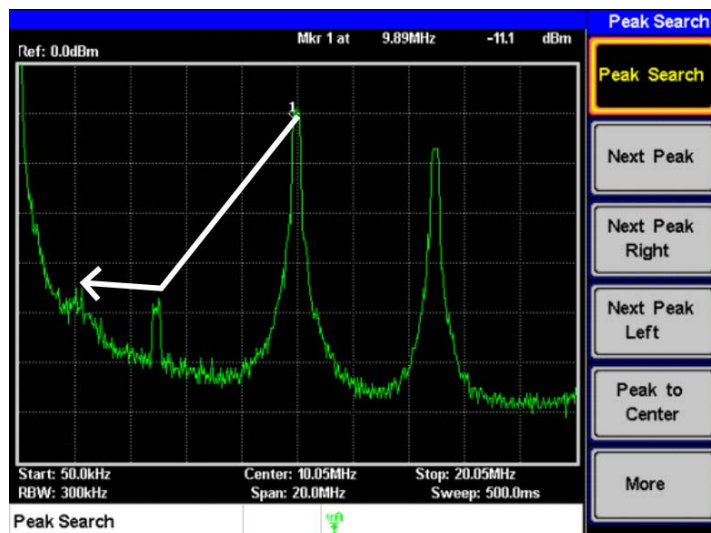

Figure 34. Next Peak Left.

3.5.5 Peak Table

The Peak Table function will display up to 5 peaks. The amplitude and frequency for each peak is listed.

- 1 Press **Peak Search** ► **More** (F6) ► **Peak Table** (F2) and turn the peak table on.
- 2 Press **Peak Sort** (F2) and set the sorting type:
Freq: Sort by frequency in ascending order.
Amp: Sort by amplitude in ascending order.



The bottom-half of the screen shows the peak table with the peak marker no., frequency and amplitude.

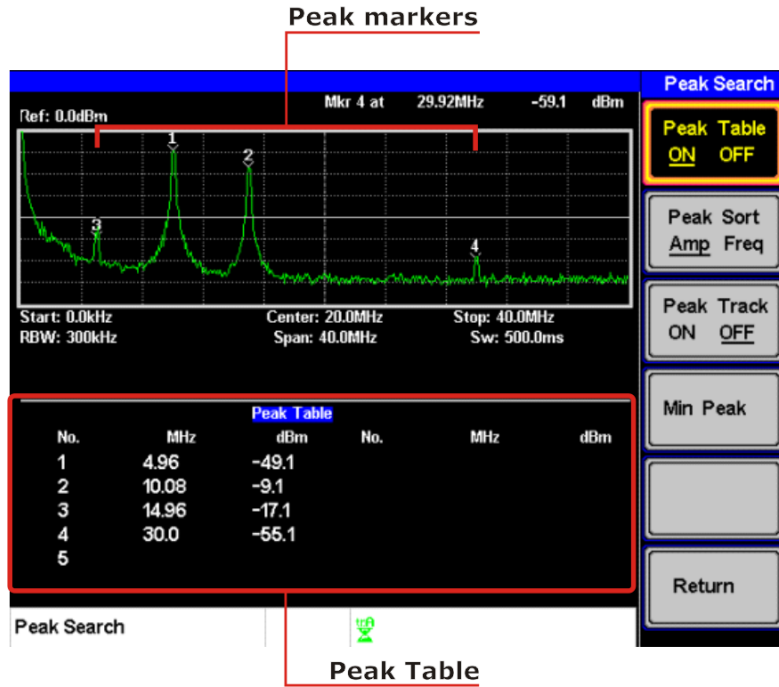

Figure 35.



3.6 Measurement

This section describes how to use the automatic measurement modes. The **AE-366B** includes the following measurements:

- ACPR.
- OCBW.

3.6.1 Channel Analysis Overview

Channel analysis measurement includes ACPR (adjacent channel power) and OCBW (occupied bandwidth) measurements.

► Parameters:

- **Channel bandwidth:**
The frequency bandwidth the target channel occupies.
Range: Between 0 Hz ~ 3 GHz (0 Hz excepted).
- **Channel Space:**
The frequency distance between each main channel.
Range: Between 0 Hz ~ 3 GHz.
- **Adjacent channel bandwidth 1 & 2:**
The frequency bandwidth the adjacent channels occupy.
Range: Between 0 Hz ~ 3 GHz (0 Hz excepted).
- **Adjacent channel offset 1 ~ 2**
The frequency distance between the adjacent channels and main channel.
Range: 1 Between 0 Hz ~ 3 GHz (0 Hz excepted).
- **OCBW%**
The ratio of occupied bandwidth to the amount of power consumed.
Range: 0 % to 100 %, 0,1 % resolution.



3.6.1.1 ACPR

Adjacent channel power refers to the amount of power leaked to the adjacent channel from the main channel. This measurement is a ratio of the main channel power to power in the adjacent channel.

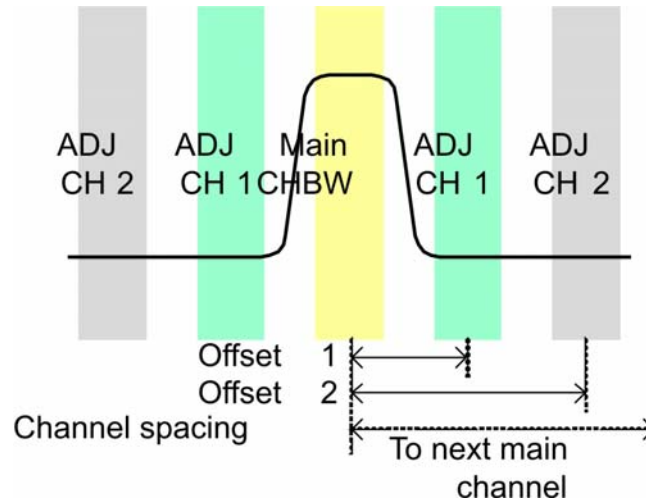

Figure 36.

► **Operation:** Setting up the main channel.

1 Press **Meas** ► **ACPR** **F2** and turn ACPR on.

● **Any other measurement mode will automatically be disabled.**

2 The display splits into two screens. The top screen shows the sweep waveform. The bottom screen shows the ACPR settings and measurement results in real time.



- Turn ACPR off to return back to the normal mode.

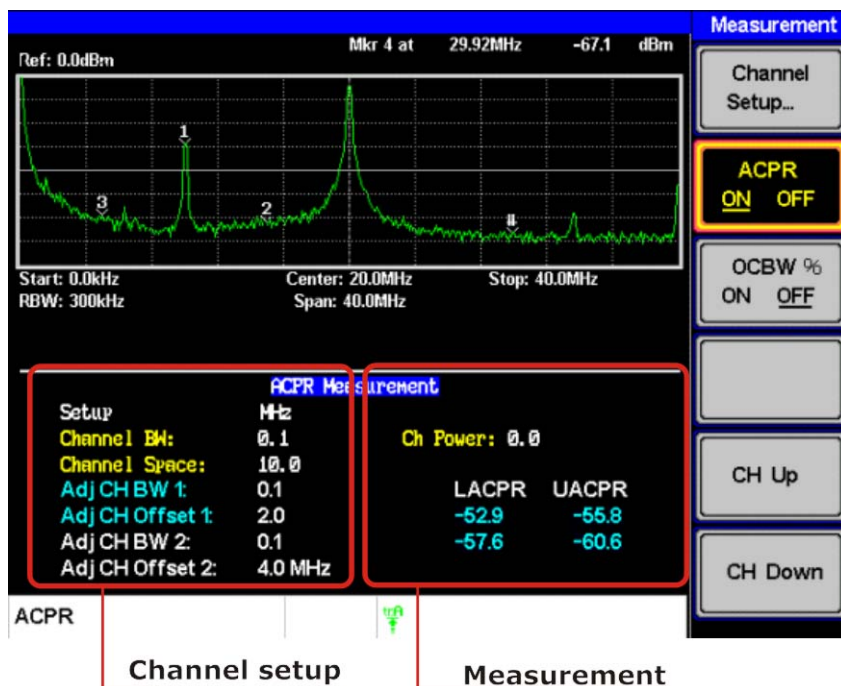

Figure 37.

- 3 Press **Channel Setup...** (F1) and set the following:
 - Main CH BW** (F1): Set the bandwidth of the main channel.
 - Main CH Space** (F2): Specify the channel spacing.

NOTE: The main channel bandwidth and space settings are shown in the setup area at the bottom of the screen, not on the soft-key icon.

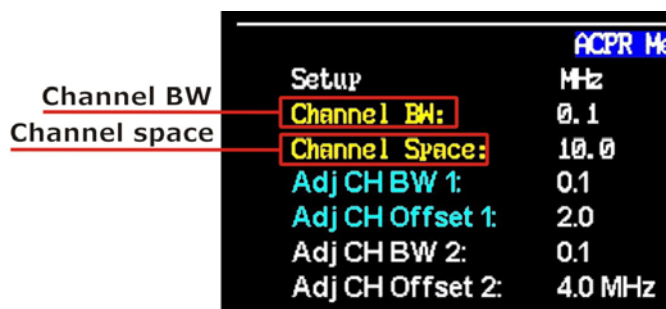

Figure 38.



► **Operation:** Setting up the adjacent channel(s).

- 1 Press **ADJCH Setup...** (F3) to setup the adjacent channels:
 - Adj CH BW 1** (F1): Sets the bandwidth of the 1st adjacent channel.
 - Adj CH Offs 1** (F2): Sets the channel offset of the 1st adjacent channel.
 - Adj CH BW 2** (F3): Sets the bandwidth of the 2nd adjacent channel.
 - Adj CH Offs 2** (F4): Sets the channel offset of the 2nd adjacent channel.

NOTE: The adjacent channel bandwidth and space settings are shown in the setup area at the bottom of the screen, not on the soft-key icons.

	Channel Space:	10.0
Adj CH 1 settings	Adj CH BW 1:	0.1
	Adj CH Offset 1:	2.0
Adj CH 2 settings	Adj CH BW 2:	0.1
	Adj CH Offset 2:	4.0 MHz

Figure 39.

■ **Move Channels Up/Down**

- 1 Press the **Meas** again or press **Return** (F6) repeatedly to return to the start of the Measure menu tree.
- 2 Press **CH Up** (F5) to go to the next main channel.
- 3 Press **CH Down** (F6) to go to the previous main channel.

NOTE: The channel space (Main CH Space) setting determines where the next main channel is located.



3.6.1.2

OCBW

Occupied bandwidth measurements are used to measure the power of the occupied channel as a percentage to the power of the channel.

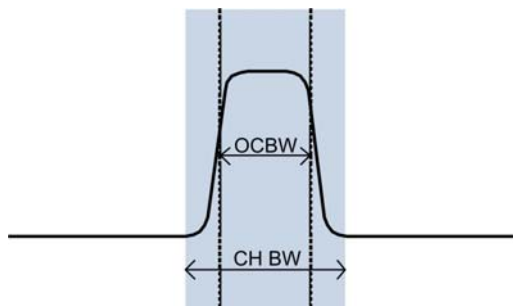

Figure 40.

► **Operation:** Setting up the main channel.

1 Press **Meas** ► **OCBW %** **F3** and turn OCBW on.

● Any other measurement mode will automatically be disabled.

2 The display splits into two screens. The top shows the channel bandwidth. The bottom screen shows the OCBW measurement results in real time.

● Turn OCBW off to return back to the normal mode.

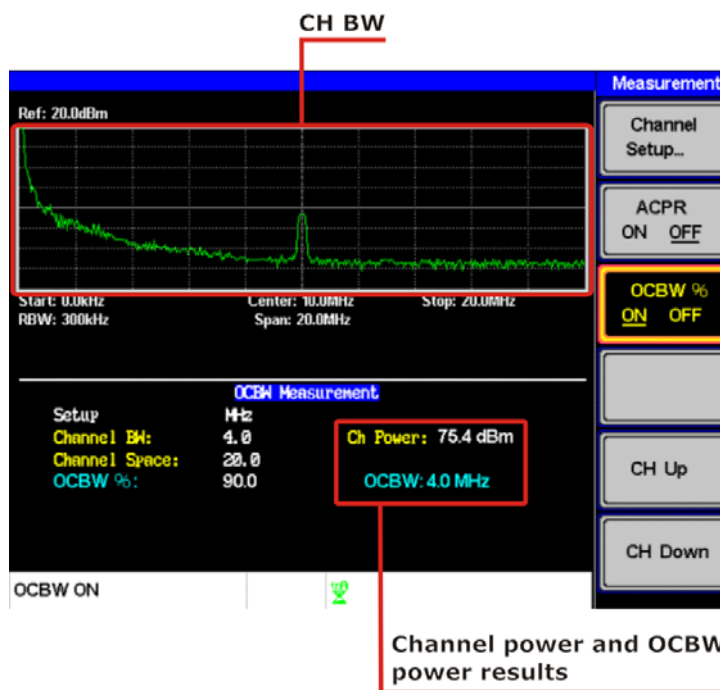

Figure 41.



3 Press **Channel Setup...** ^{F1} and set the following:

Main CH BW ^{F1}: Set the bandwidth of the main channel.

Main CH Space ^{F2}: Specify the channel spacing.

NOTE: The main channel bandwidth and space settings are shown in the setup area at the bottom of the screen, not on the soft-key icon.

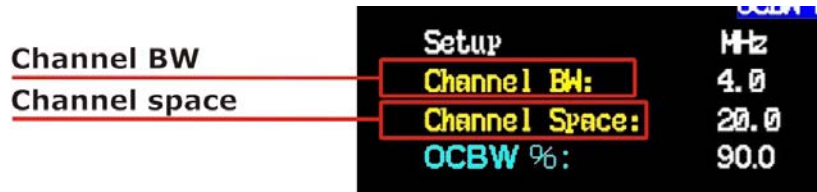

Figure 42.

■ **Move Channels Up/Down**

1 Press the **Meas** again or press **Return** ^{F6} repeatedly to return to the start of the Measure menu tree.

2 Press **CH Up** ^{F5} to go to the next main channel.

3 Press **CH Down** ^{F6} to go to the previous main channel.

NOTE: The channel space (Main CH Space) setting determines where the next main channel is located.



3.7 Limit Line Testing

The Limit Line function is used to set the upper or lower amplitude limits over the entire frequency range. The limit lines can be used to detect whether the input signal is above, below or within the limit lines.

The limit lines can be manually edited using 10 frequency points from the start to the stop frequencies.

3.7.1 Activate a Limit Line

- 1 Press **Limit Line** to enter the Limit Line menu.
- 2 Press **H Limit** (F1) or **L Limit** (F2) and turn the high or low limit on or off.

H Limit/L Limit: On, Off

 - The H Limit is shown as a blue line.
 - The L Limit is shown as a pink line.

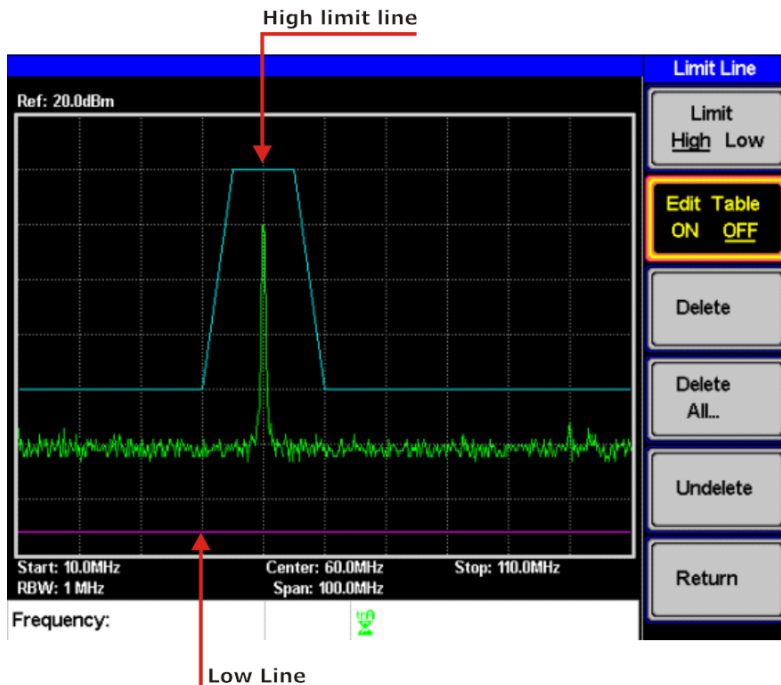

Figure 43.



3.7.2 Creating a Limit (Point by Point)

Create a limit manually, point by point. Ten manually selected frequency points can be used to create the upper or lower limit line.

- 1 Press **Limit Line** ► **Edit** (F3) ► **Limit** (F2) and select the limit line you wish to edit.

Limit: High, Low.

- 2 Press **Edit Table** (F2) and turn the edit table on.

The **AE-366B** is split into two screens. The top screen shows the trace and the selected limit line (high or low) and the bottom screen shows the limit line table.

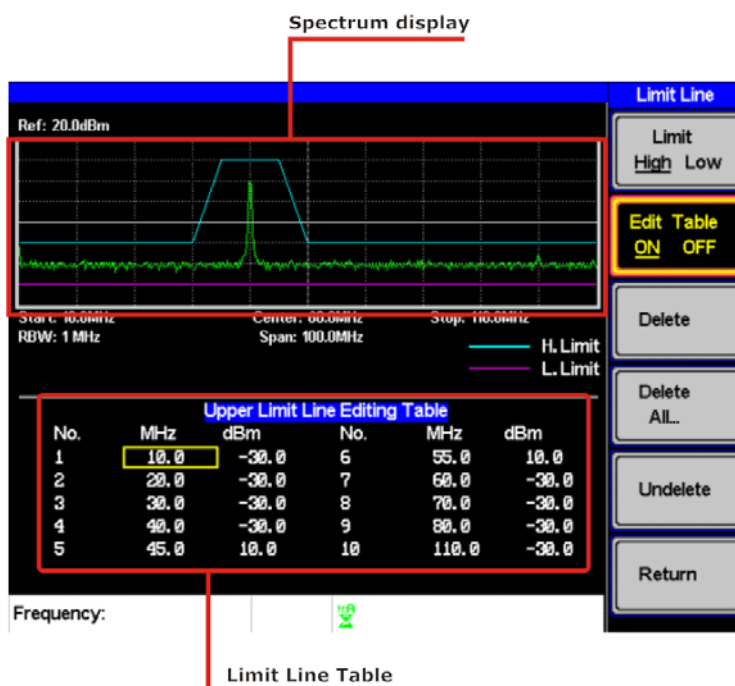

Figure 44.

All 10 points will be displayed in a limit line table at the bottom of the display. By default, each point is set to 0 dBm.



- 3 Use the arrow keys to move the cursor to the frequency column of the desired point.

Cursor

Upper Limit Line Editing Table					
No.	MHz	dBm	No.	MHz	dBm
1	10.0	00.0	6	55.0	10.0
2	20.0	-30.0	7	60.0	-30.0
3	30.0	-30.0	8	70.0	-30.0
4	40.0	-30.0	9	80.0	-30.0
5	45.0	10.0	10	110.0	-30.0

Figure 45.

- 4 Enter the new frequency and amplitude of the point using the keypad and the unit keys.
- 5 Repeat steps 3-5 for the remaining points (A maximum of ten points).
- 6 To delete the selected point, press Delete (F3).
- 7 To delete all the points, press Delete All... (F4).
 - The points will revert to their default frequency and amplitude values.
- 8 To delete a point from the editing table, press Delete.
 - The whole points, including the frequency value and the amplitude are removed. This command reduces the number of points used in the limit line.
- 9 Press Undelete (F5) the restore the last point that was deleted.

3.7.2.1 Pass/Fail Testing

The Pass/Fail testing uses the limit lines as boundaries. When the input signal escapes the boundary of the limit lines, then the test is judged as a FAIL, if the signal stays within the boundary, the test is judged as a PASS.

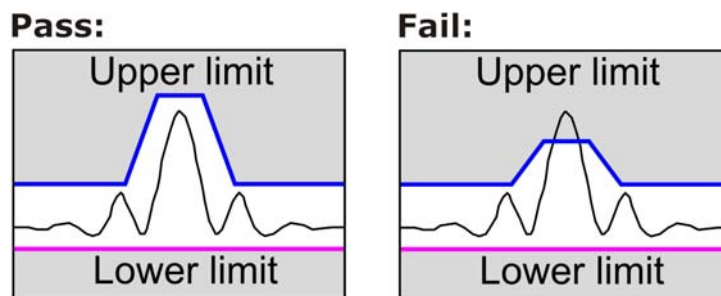



Figure 46.



 **NOTE:** Before pass/fail testing can begin, limit lines for the upper and/or lower limits must first be saved and activated.

- 1 Press  ► **Pass/Fail**  to turn the testing on or off.
- 2 The test result is updated in real-time at the bottom of the display.

Pass: PASS

Fail: FAIL

 **NOTE:** At least one limit line (high or low) must be turned on to enable testing.

If only high limit line is on, each trace point has to be lower than the high limit line to get a PASS judgment, otherwise get the judgment will be FAIL.

Conversely, if only low limit line is on then each trace point has to be higher than the low limit line to get a PASS, otherwise get the test will be judged a FAIL.



3.8 Bandwidth

BW key sets the resolution bandwidth (RBW). The resolution bandwidth and the sweep time are related. Please take into account how the sweep time is effected by the resolution bandwidth.

3.8.1 Resolution Bandwidth Setting (RBW)

The RBW (Resolution Bandwidth) defines the width of the IF (intermediate frequency) filter that is used to separate signal peaks from one another. The narrower the RBW, the greater the capability to separate signals at close frequencies. But it also makes the sweep time longer under specific frequency spans (the display is updated less frequently).

1 Press  ► **RBW**  and set the RBW to Auto or Man.

2 Set the resolution bandwidth and unit for Man mode.

Mode: Auto, Man.

Frequency Range: 1 MHz, 300 kHz, 100 kHz.

 **NOTE:** The manual RBW is only available when the span ≤ 10 MHz. If the span is greater than 10 MHz then the RBW is automatically set to Auto.



3.9 Trace

The **AE-366B** is able to set the parameters of up to 3 different traces on the display at once. Each trace is represented by a different color and is updated with each sweep.

3.9.1 Selecting a Trace

Each trace (A, B, C) is represented by a different color. Trace A is green, trace B is orange and trace C is yellow. When activated, an icon for each trace color and function is shown at the bottom of the display. When a trace is selected, parameters can be set/edited from the Trace menu.

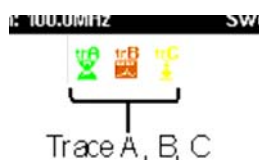









Figure 47.

► Trace Type & Icon

The type of trace used determines how the trace data is stored or manipulated before being displayed. The analyzer updates each trace according to the type of trace used.

-  **Clear & Write:**
 The **AE-366B** continuously updates the display with each sweep. This is the default trace type.
-  **Peak Hold,**  **Min Hold:**
 The maximum or minimum points are maintained for the selected trace. The trace points are updated each sweep if new maximum or minimum points are found.
-  **View:**
 View will hold the selected trace and stop updating the trace data for the selected trace. Pressing **View**  will display the trace data that was cleared using the **Blank**  key.



- **Blank:**
Clears the selected trace from the display and stores trace data. The trace data can be restored by pressing **View** .

► **Operation**

- 1 Press  ► **Trace**  and choose a trace.

Trace: A, B, C.

- 2 Select the trace type:

Clear & Write 

Peak Hold 

View 

Blank 

More  > **Min Hold** 



NOTE: Traces B and C are set to **Blank** by default.



3.9.2 Trace Math

Performs trace math from two traces (A, B) and stores the results in trace A or swaps the data from trace A to trace B.

■ **Math functions:**

- A <--> B:** Swaps the data from trace A to B and vice versa.
- A + B -> A:** Adds trace A and B and stores the result in trace A.
- A - B -> A:** Subtracts trace B from trace and stores the result in trace A.
- A + const ->A:** Adds an offset to trace A.
- A - const ->A:** Subtracts an offset from trace A.

1 Press  > **Trace Math...**  and select a trace math function.

A <--> B 

A + B -> A 

A - B -> A 

A + const ->A 

A - const ->A 

2 If **A + const ->A** or **A - const ->A** was selected, set the constant (offset value).

Constant: -40 dBm ~ 40 dBm.

3.9.3 Average Trace

The Average function averages the currently selected trace for a user-defined number of times before it is displayed. This feature smoothes the noise level, but has the drawback of slowing down the display update rate.

1 Press  ► **More**  and toggle Avg on.

2 Set the number of averages.

Range: 4 ~ 100.

Default: 4

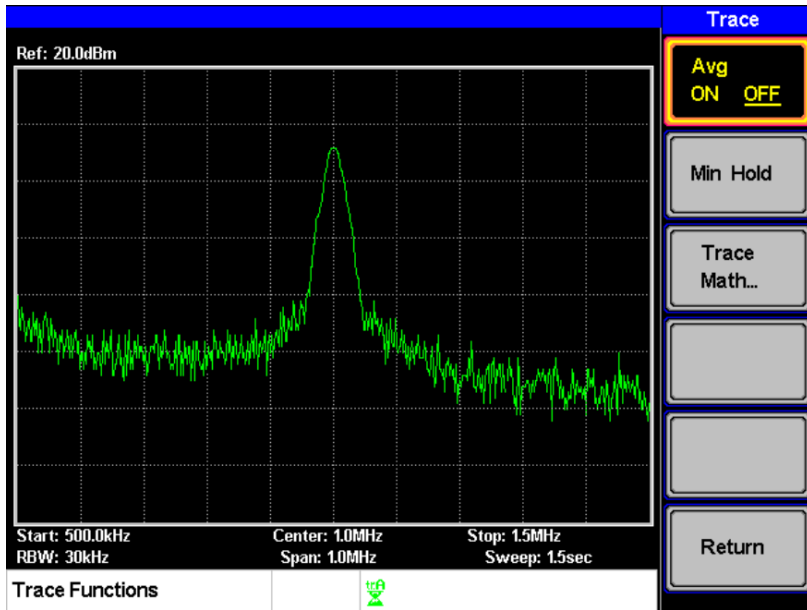

Figure 48. Average:Off.

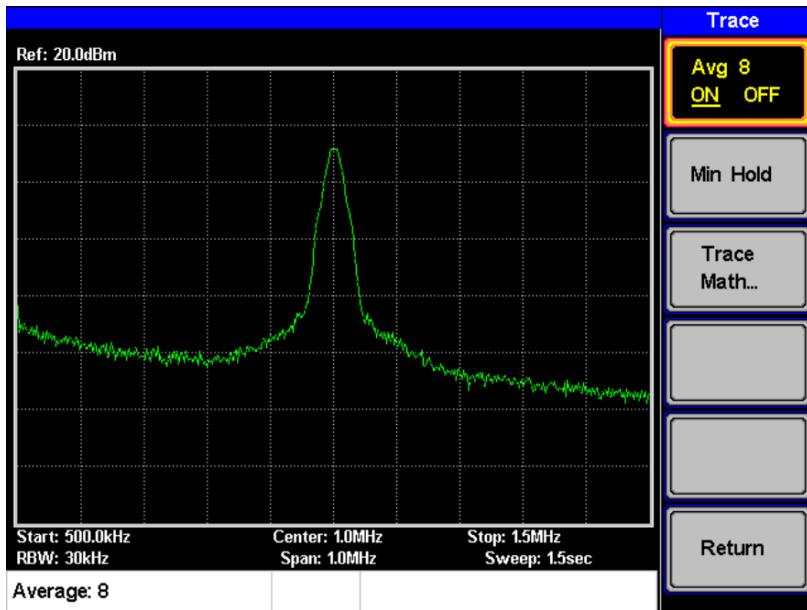

Figure 49. Average:On (8x).



3.10 Display

The Display key configures the basic display settings as well as the split screen modes.

3.10.1 Adjusting the LCD Brightness

The LCD brightness levels can be adjusted to five pre-set levels.

- 1 Press **Display** ► **LCD Dimmer** (F1) and use either the number pad, the scroll wheel or arrow keys to set the brightness.

3.10.2 Setting a Display Line (Reference Level Line)

The Display Line function is used to super-impose a reference level line over the traces.

- 1 Press **Display** ► **Display Line** (F3) to turn the display line on.
- 2 Set the display line level and press **Enter**.

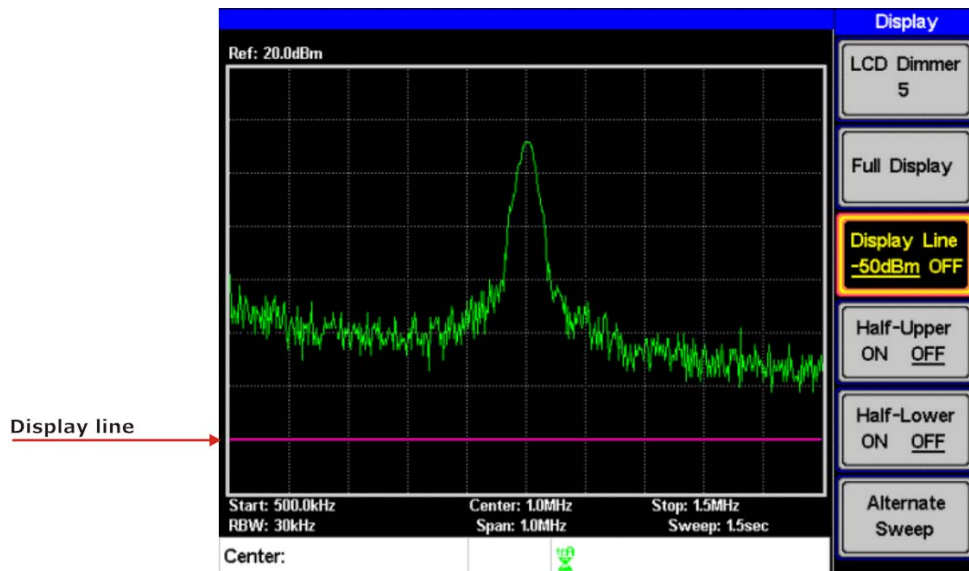

Figure 50. Display line set at -50dBm.



3.10.3 Using the Video Out Port

The **AE-366B** has a dedicated VGA terminal to output the display to an external monitor. The video output is always on.

Output resolution: 480 x 640 (fixed).

- 1 Connect an external monitor to the rear panel VGA terminal



3.10.4 Split Spectrum View

The split spectrum view is able to view two different sweep ranges on the display at the same time using a split screen view. The top and bottom view can have independent sweep ranges, amplitudes, spans and other settings. However only one split screen (top or bottom) can be swept each time.

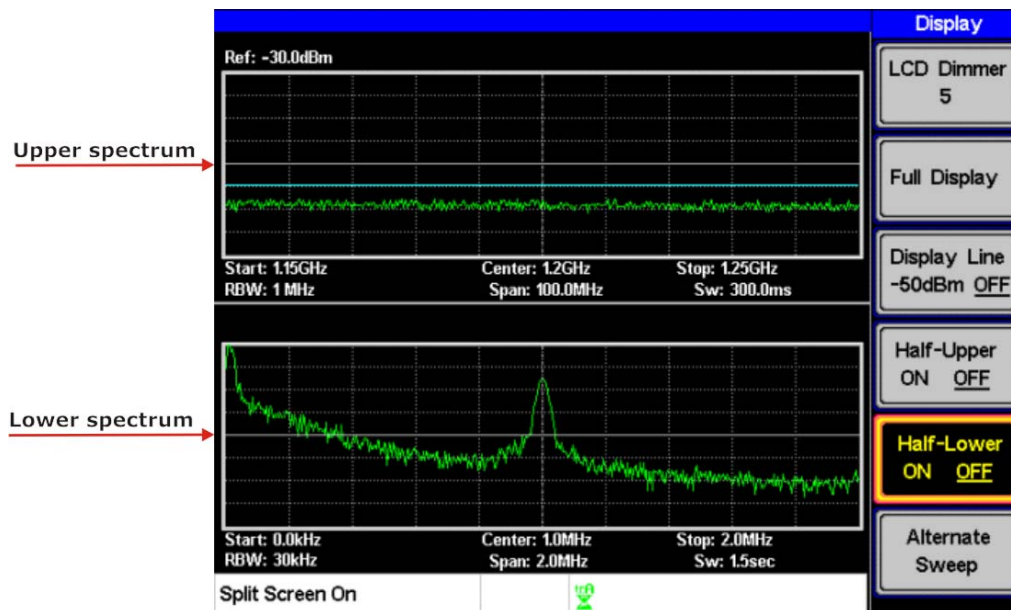

Figure 51.

► Split Spectrum Functions

■ Half-Upper:

Half-Upper will put the spectrum analyzer into split screen mode. It will make the top sweep the active sweep and pause the bottom sweep. When Half-Upper is on, only the upper sweep parameters can be edited.



■ **Half-Lower:**

Half-Lower will put the spectrum analyzer into split screen mode. It will make the bottom sweep the active sweep and pause the top sweep. When Half-Lower is on, only the lower sweep settings can be edited.

■ **Alternate Sweep:**

This setting will alternate the sweep between the bottom and top spectrums. If alternate sweep is turned on, only the upper sweep parameters can be edited.

► **Operation**

1 Press  > **Half-Upper**  or **Half-Lower**  or **Alternate Sweep**  to enable the split spectrum view.

- **Turning Half – Upper on will automatically turn Half-Lower off.**
- **Turning Half – Lower on will automatically turn Half-Upper off.**
- **If Alternate Sweep is turned on, each sweep will alternate, but only the upper sweep parameters can be edited.**

2 To return to a full - screen, single spectrum display, press **Full Display** .



NOTE: After exiting the split spectrum view, the analyzer will use the settings from the active window. The settings for the inactive screen will be retained for the next time that split spectrum view is used.

If the spectrum analyzer was in the Alternate mode, then the upper sweep settings will be returned.



3.11 Save/Recall Files

The **AE-366B** can save and recall setup data, trace data and limit line data to and from internal memory. There are five memory locations for each save file type. These files cannot be saved to USB.

The Hardcopy key can be used to save image files to a USB flash drive.



3.11.1 Save/Recall Setup

Setup data contains all the data necessary to recall the state of the **AE-366B** to known state.

Setup data contains the following data:

Center frequency, Start frequency, Stop frequency, Step frequency, Ref. Level, Scale, Units, RBW.

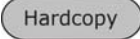
■ Save:

- 1 To save the current settings, press  ► **Setup To**  and choose a memory location to save to with the arrow keys.

Setup To: 1 ~ 5.

- 2 Press   to execute the save.

■ Recall:

- 1 To recall a setup, press  ► **Setup From**  and choose a memory location to recall from with the arrow keys.

Setup From: 1 ~ 5.

- 2 Press   to execute the recall.







3.11.2 Save/Recall Trace Data



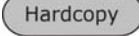

The trace data can be saved/recalled for any of the A, B or C traces to/from one of 5 pre-set internal memory locations. The trace data cannot be recalled or saved to USB.

When saving or recalling trace data from a split spectrum, only the active spectrum is saved/recalled.

■ Save:

- 1 To save the current trace data, press  ► **Save Trace Data.** 
- 2 Press **Source Trace**  and select the source:
Source: A, B, C.
- 3 Press **Destination**  and select the memory location to save to:
Destination: 1 ~ 5.
- 4 Press **Start**  to save the selected trace data.

■ Recall:



- 1 To recall trace data, press  ► **Recall Trace Data** .
- 2 Press **Source Trace**  and select the memory location to recall from:
Source: 1 ~ 5.
- 3 Press **Destination**  and select the destination trace:
Destination: A, B, C.
- 4 Press **Start**  to save the selected trace data.



3.11.3 Save/Recall Limit Lines

Upper and lower limit lines can be saved to one of 5 pre-set internal memory locations. The limit line data cannot be saved to USB.

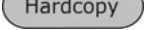

■ Save:

- 1 To save the current upper and lower limit lines, press  > **LimitIn to**  and choose a memory location to save to with the arrow keys.

Limit line: 1 ~ 5.

- 2 Press   to execute the save.

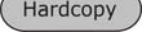
■ Recall:

- 1 To recall pre-saved upper and lower limit lines, press  ► **LimitIn from**  and choose a memory location to recall from with the arrow keys.

Limit line: 1 ~ 5.

- 2 Press   to execute the recall.

3.11.4 Saving an Image File (Hardcopy)

The Hardcopy key can be used to save a screenshot of the display to a USB flash drive. The screen shot is saved as a bitmap file.

- 1 Insert a USB flash drive into the USB port.

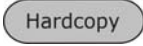
- 2 Press  and the image file will begin saving.

- **Wait a few moments for the file to save. When the file has finished saving, "Screen Saved OK" will appear at the bottom of the display.**



NOTE: The file name will be automatically created in the following format: File name: SCRXX.bmp Where XX is a number that is incremented each time the file is saved.

WARNING: Do not remove the USB drive until the file has completed saving.

3.11.5 **Hardcopy Setup**

The Hardcopy Setup key is used set the image file properties of the bitmap file that is created when the Hardcopy key is pressed.

- **Ink Normal:**
This is the normal, default image setting.
- **Ink Saving:**
This will invert all the colors on the display so that the file will conserve ink when printed.

1 Press  and choose the image type:

Ink Normal 

Ink Saving 

NOTE: The next time the Hardcopy key is pressed, the image will be saved using the settings above.

3.11.6 **Load Default Settings**

The Preset key is used to load the default settings.

1 Press .

- **The system will load the preset settings and the screen will update with the new settings.**

NOTE: The default settings cannot be changed.



3.12 System Settings

3.12.1 System Information

► Description

The System Information displays the following:

- **Serial Number:**
XX digit serial number.
- **HW Version:**
Hardware version.
- **FW Version:**
Firmware version.
- **SW Version:**
Software version.
- **Language:**
Shows the language number as seen in the System>Language menu.

► Operation

1 Press **System** ► **Information** (F4) to display the system information.

- The system information will be displayed on the system menu soft-keys.

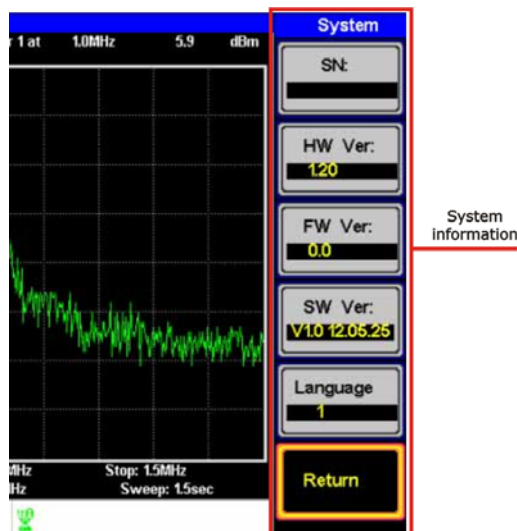



Figure 52.



3.12.2 System Language

The language option sets the icon display language.

- 1 Press  ► **Language...**  to bring up the Language menu.
- 2 Choose a system language. The language number is the number that will be displayed in the system information.



4 REMOTE CONTROL

This chapter describes basic configuration of IEEE488.2 based remote control.

4.1 Interface Configuration

4.1.1 Configure Remote Interface

- **USB configuration:**

PC side connector:	Type A, host.
Equipment side connector:	Rear panel Type B, slave.
Speed:	1.1/2.0 (full speed).

- **RS 232 configuration:**

PC side connector:	RS232 male port.
Equipment side connector:	RS232 female port.
Baud Rate:	9600, 19200, 38400, 57600, 115200.
Parity:	None, Even, Odd, Space, Mark, Multidrop.
Stop bit:	1, 1.5, 2.
Data bit:	5, 6, 7, 8.

The **AE-366B** can use either the type B USB port or the RS232 on the rear panel for remote control.

When using the USB B port, the **AE-366B** uses a USB driver to simulate an RS232 connection with a PC via USB. It is these RS232 settings that are configured for remote control.

Before using the USB B port for remote control, please install the USB driver.



► Panel Operation

1 USB Connection:

- Connect a USB cable from the PC to the rear panel USB B port.



RS232 Connection:

- Connect an RS232C cable from the PC to the rear panel RS232

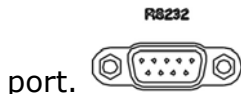

- 2 Press **System** ► **Serial Port...** (F1) ► **Serial** (F1) to enter the remote configuration.

- 3 Set the following RS-232 settings using the arrow keys:

Baud Rate (F1): 9600, 19200, 38400, 57600, 115200.

Parity (F2): None, Even, Odd, Space, Mark, Multidrop.

Stop Bit (F3): 1, 1.5, 2.

Data (F4): 5, 6, 7, 8.

4.1.2 Remote Control Function Check

Invoke a terminal application such as MTTY (Multi-Threaded TTY).

To check the COM port No., see the Device Manager in the PC.

For **WinXP** go to;

Control panel → System → Hardware tab.

Run this query command via the terminal after the instrument has been configured for remote control.

***idn?**

This should return the Manufacturer, Model number, Serial number, and Firmware version.

 **NOTE:** For further details or if you have trouble running this function check, please see the programming manual.



4.2 Command Syntax

■ **Compatible Standard:**

IEEE488.2 Partial compatibility.

SCPI, 1999 Partial compatibility.

■ **Command Structure:**

SCPI (Standard Commands for Programmable Instruments) commands follow a tree-like structure, organized into nodes. Each level of the command tree is a node. Each keyword in a SCPI command represents each node in the command tree. Each keyword (node) of a SCPI command is separated by a colon (:).

For example, the diagram below shows an SCPI sub-structure and a command example.

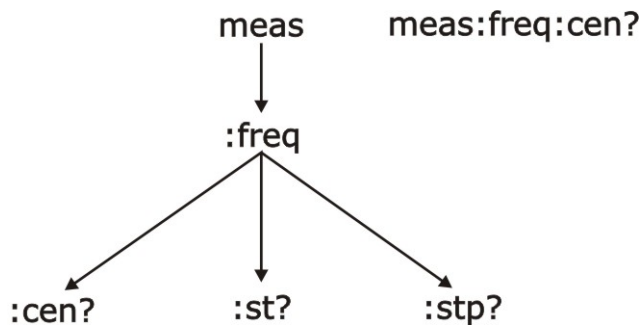

Figure 53.

■ **Command types:**

There are a number of different instrument commands and queries. A command sends instructions or data to the unit and a query receives data or status information from the unit.

Single Command A single command with/without a parameter.

Example: meas:freq:cen 100 MHz

Query A query is a simple or compound command followed by a question mark (?). A parameter (data) is returned.

Example: meas:freq:cen?



■ **Command Format:**

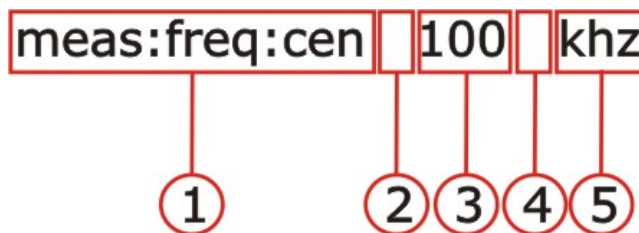

Figure 54.

- ① Command header.
- ② Space.
- ③ Parameter 1.
- ④ Optional space.
- ⑤ Unit or suffix.

■ **Common Input/Return Parameters:**

Type	Description	Example
<Boolean>	Boolean logic	0, 1
<NR1>	integers	0, 1, 2, 3
<NR2>	decimal numbers	0.1, 3.14, 8.5
<NRf>	any of NR1, 2	1, 1.5
<freq>	<NRf> + unit Unit = kHz, MHz, GHz. Note: The unit can be omitted (defaults to currently set unit).	2.5 mhz
<refl>	<NRf> + unit Unit = dBm, dBmV, dBuV Note: The unit can be omitted (defaults to currently set unit).	-30 dBm
<ampl>	NR3 +unit Note: The unit can be omitted. (Unit defaults to current unit)	30.0 dBm
<trace data>	{ -92, -91,, -89, -92, -92, -91 } CSV data that represents each point in a trace.	
<string>	ASCII string data.	

■ **Message Terminator:**

- LF Line feed code (0x0A).



4.3 Command List

4.3.1 IEEE488.2 Standard Commands

Name	*IDN?
Description	Queries the manufacturer, model number, serial number, and firmware version of the instrument.
Query Syntax	*IDN?
Return parameter	<string> Returns the instrument identification

4.3.2 Sweep Commands

Name	si
Description	Stops the sweep.
Example	si

Name	sn
Description	Continues a stopped sweep.
Example	sn

Name	ts
Description	Resets the sweep and starts it once (i.e., sweeps one time).
Example	ts

4.3.3 Frequency Commands

Name	meas:freq:cen	
Description	Sets or queries the center frequency.	
Syntax	meas:freq:cen<freq>	
Query Syntax	meas:freq:cen?	
Parameter	<freq>	Center frequency.
Return parameter	<freq>	Returns the frequency and unit.
Example	meas:freq:cen 100kHz Sets the center frequency to 100kHz.	
Query example	meas:freq:cen? >100 kHz	



Name	meas:freq:st	
Description	Sets or queries the start frequency.	
Syntax	meas:freq:st<freq>	
Query Syntax	meas:freq:st?	
Parameter	<freq>	Start frequency.
Return parameter	<freq>	Returns the start frequency and unit.
Example	meas:freq:st 100mhz Sets the start frequency to 100MHz	
Query example	meas:freq:st? >100000 kHz	

Name	meas:freq:stp	
Description	Sets or queries the stop frequency	
Syntax	meas:freq:stp<freq>	
Query Syntax	meas:freq:stp?	
Parameter	<freq>	Stop frequency.
Return parameter	<freq>	Returns the stop frequency and unit.
Example	meas:freq:stp 100 mhz Sets the stop frequency to 100MHz	
Query example	meas:freq:stp? >100000 kHz	

4.3.4 **Span Commands**

Name	meas:span	
Description	Sets or queries the frequency span	
Syntax	meas:span <freq>	
Query Syntax	meas:span?	
Parameter	<freq>	Span frequency range.
Return parameter	<freq>	Returns the span and unit.
Example	meas:span 10 mhz Sets the span to 10MHz	
Query example	meas:span? >10000.0 kHz	

Name	meas:span:full	
Description	Sets the span to the full span.	
Syntax	meas:span:full	



4.3.5 Amplitude Commands

Name	meas:refl:unit	
Description	Sets the reference level unit	
Syntax	meas:refl:unit {1/2/3}	
Query Syntax	meas:refl:unit?	
Parameter/Return parameter	1	dBm
	2	dBmV
	3	dB μ V
Query example	meas:refl:unit? >1 The reference level unit are dBm.	

Name	meas:refl	
Description	Sets or queries the reference level.	
Syntax	meas:refl <refl>	
Query Syntax	meas:refl?	
Parameter	<refl>	Reference level in the currently selected unit (from the meas:refl:unit command).
Return parameter	<refl>	Returns reference level and unit.
Example	Meas:refl 10 Sets the reference level to 10 dBm (for unit = dBm).	
Query example	meas:refl? >10 dBm	

4.3.6 Marker and Peak Search Commands

Name	meas:mark:on	
Description	Sets or queries which markers are turned on.	
Syntax	meas:mark:on {<NR1>/all}	
Query Syntax	meas:mark:on <NR1>?	
Parameter	<NR1> all	Marker number 1~5. All markers.
Return parameter	ON OFF	The selected marker is on. The selected marker is off.
Example	meas:mark on 1 Turns marker 1 on.	
Query example	meas:mark 1? >OFF	



Name	meas:mark:off	
Description	Sets which markers are turned off.	
Syntax	meas:mark:off {<NR1>/all}	
Parameter	<NR1> All	Marker number 1~5. All markers.
Example	meas:mark off 1 Turns marker 1 off.	

Name	meas:mark:norm	
Description	Sets the selected marker to normal mode.	
Syntax	meas:mark:norm<NR1>	
Parameter	<NR1>	Marker number 1~5.
Example	meas:mark:norm 1 Sets marker 1 to normal mode.	

Name	meas:mark:norm:freq?	
Description	Queries the frequency of the selected normal marker.	
Query syntax	meas:mark:norm:freq <NR1>?	
Parameter	<NR1>	Marker number 1~5.
Return parameter	<freq>	Returns the frequency and unit of the selected marker.
Example	meas:mark:norm:freq1? >1.5GHz.	

Name	meas:mark:norm:level?	
Description	Queries the amplitude of the selected normal marker.	
Query syntax	meas:mark:norm:level <NR1>?	
Parameter	<NR1>	Marker number 1~5.
Return parameter	<amp>	Returns the amplitude and unit of the selected marker.
Example	meas:mark:norm:level1? >10.0dBm.	

Name	meas:mark:delta	
Description	Sets the selected marker to delta mode. It also sets the relative frequency of the delta marker (in relation to the normal marker frequency).	
Syntax	meas:mark:delta <NR1> <freq>	
Parameter	<NR1>	Marker number 1~5.
	<freq>	Relative frequency of the delta marker.
Example	meas:mark:freq110 MHz Turns delta marker 1 on and sets its offset to 10MHz.	



Name	meas:mark:delta:freq?	
Description	Queries the (relative) frequency of the selected delta marker.	
Query syntax	meas:mark:delta:freq <NR1>?	
Parameter	<NR1>	Marker number 1~5.
Return parameter	<freq>	Returns the relative frequency and unit of the selected delta marker.
Example	meas:mark:norm:freq1? >12.0kHz.	

Name	meas:mark:delta:level?	
Description	Queries the amplitude of the selected delta marker.	
Query syntax	meas:mark:delta:level <NR1>?	
Parameter	<NR1>	Marker number 1~5.
Return parameter	<amp>	Returns the amplitude and unit of the selected delta marker.
Example	meas:mark:delta:level1? >10.0dBm.	

Name	meas:mark:tomin	
Description	Sets the selected marker to the minimum peak.	
Syntax	meas:mark:tomin <NR1>	
Parameter	<NR1>	Marker number 1~5.
Example	meas:mark:tomin1 Sets marke 1 to the minimum peak.	

Name	meas:mark:topeak	
Description	Sets the selected marker to the peak.	
Syntax	meas:mark:topeak <NR1>	
Parameter	<NR1>	Marker number 1~5.
Example	meas:mark:topeak1 Sets marker 1 to the peak.	

Name	meas:mark:tonp	
Description	Moves the selected normal or delta marker to the next peak.	
Syntax	meas:mark:tonp <NR1>	
Parameter	<NR1>	Marker number 1~5.
Example	meas:mark:tono1 Moves marker 1 to the next peak.	



Name	meas:mark:trace	
Description	Sets the selected marker to the selected trace.	
Syntax	meas:mark:topeak <NR1> <trace>	
Parameter	<NR1>	Marker number 1~5.
	<trace>	0 Auto (auto assign a trace)
		1 TraceA
		2 TraceB
	3 TraceC	
Example	meas:mark:trace 1 2 Sets marker 1 to trace B.	

4.3.7 Trace Commands

Name	meas:tra:val1:val2	
Description	Sets the mode for the selected trace.	
Syntax	meas:tra <trace><mode>	
Parameter	<trace>	1 Trace A
		2 Trace B
		3 Trace C
	<mode>	1 Clear and write mode
		2 Peak hold mode
		3 View mode
4 Blank Mode		
	5 Minimum hold mode	
Example	meas:tra 1 1 Sets trace A to clear and write mode.	

Name	meas:tra:avg:on	
Description	Turns the average function on and sets the number of averages for the selected trace.	
Syntax	meas:tra:avg:on <trace><NR1>	
Parameter	<trace>	1 Trace A
		2 Trace B
		3 Trace C
	<NR1>	4~20 Number of averages.
Example	meas:tra:avg:on 1 4 Sets the number of averages used for Trace A to 4.	

Name	meas:tra:avg:off	
Description	Turns the average function off for the selected trace.	
Syntax	meas:tra:avg:off <trace>	
Parameter	<trace>	1 Trace A
		2 Trace B
		3 Trace C
		all All traces.
Example	meas:tra:avg:off all Turns the average function off for all the traces.	



Name	meas:tra:read	
Description	Returns the all the trace data for the selected trace.	
Syntax	meas:tra:read? <trace>	
Parameter	<trace>	1 Trace A
		2 Trace B
		3 Trace C
		all All traces.
Return parameter	<trace data>	Comma separated data values encapsulated in brackets. I.e., {-92, -91, -90,-81}
Example	meas:tra:read?1 >{-92, -91, -90, -90, -90, -88,.....-89, -92, -92, -91} Returns the trace data for the selected trace(s). A total of 501 trace points are returned, from the start frequency to the stop frequency. If "all" is selected, the trace data is returned in three lots, {TraceA}{TraceB}{TraceC}. The units are in decibels. If the selected trace is not active, os will be returned for each trace point.	

4.3.8 Power Measurement Commands

Name	meas:acpr	
Description	Turns the ACPR function on or off, or queries its status.	
Syntax	meas:acpr {on/off}	
Query syntax	meas:acpr?	
Parameter	on	ACPR mode = on
	off	ACPR mode = off
Return parameter		
Example	meas:acpr on Turns the ACPR function on.	

Name	meas:acpr:lower?	
Description	Returns the lower ACPR measurement result for the selected channel offset (offset 1 or 2).	
Query syntax	meas:acpr:lower? {1/2}	
Parameter	1	Channel offset 1
	2	Channel offset 2
Return parameter	<NR2>	Returns the ACPR measurement result.
Example	meas:acpr:lower?1 >6.0	



Name	meas:acpr:upper?	
Description	Returns the upper ACPR measurement result for the selected channel offset (offset 1 or 2).	
Query syntax	meas:acpr:upper? {1/2}	
Parameter	1	Channel offset 1
	2	Channel offset 2
Return parameter	<NR2>	Returns the ACPR measurement result.
Example	meas:acpr:lower?1 >-11.8	

Name	meas:ocbw	
Description	Turns the OCBW function on or off, or queries its status.	
Syntax	meas:ocbw? {on/off}	
Query syntax	meas:ocbw?	
Parameter/ Return parameter	On	OCBW mode=on
	Off	OCBW mode=off
Example	meas:ocbw on Turns the OCBW function on.	

Name	meas:ocbw:bw?	
Description	Returns the OCBW in kHz.	
Query syntax	meas:ocbw:bw?	
Return parameter	<freq>	Returns the OCBW in kHz
Example	meas:ocbw:bw? >4000kHz	

Name	meas:ocbw:chpw?	
Description	Returns the channel power in the current unit.	
Query syntax	meas:ocbw:chpw?	
Return parameter	<power>	Returns the channel power
Example	meas:ocbw:chpw? >-63.5	



4.3.9 Limit Line Commands

Name	meas:Imtline:passfail	
Description	Turns the Pass/Fail test on/off or queries its state.	
Syntax	meas:Imtline:passfail {on/off}	
Query syntax	meas:Imtline:passfail	
Parameter	On	Turns the pass/fail test on.
	Off	Turns the pass/fail test off.
Return parameter	0	Fail
	1	Pass
Query Example	meas:Imtline:passfail? >0	

Name	meas:Imtline:on	
Description	Turns the limit lines on.	
Syntax	meas:Imtline:on	

Name	meas:Imtline:off	
Description	Turns the limit lines off.	
Syntax	meas:Imtline:off	

4.3.10 BW Commands

Name	con:rbw:auto	
Description	Sets the RBW to Auto.	
Syntax	con:rbw:auto	

Name	con:rbw?	
Description	Returns the RBW.	
Query syntax	Con:rbw?	
Return parameter	<NR1>	0 30kHz
		1 100kHz
		2 300kHz
		3 1MHz
Example	Con:rbw? >1	



Name	con:rbw:man	
Description	Sets the RBW for manual mode.	
Syntax	Con:rbw:man {0/1/2/3/}	
Return parameter	<NR1>	1 100kHz
		2 300kHz
		3 1MHz
Example	con:rbw:man1 Sets the RBW to 100kHz.	

Name	con:rbw:mode?	
Description	Returns the RBW mode.	
Query Syntax	con:rbw:mode?	
Return parameter	auto	Auto mode
	manual	Manual mode
Example	con:rbw:mode? >auto	

Name	con:swt?	
Description	Returns the sweep time in milliseconds.	
Query Syntax	con:swt?	
Return parameter	<NRf>	
Example	con:swt? >1500	

4.3.11 Display Commands

Name	con:disp:split:upper	
Description	Turns on the split window function and sweeps the top window.	
Syntax	Con:disp:split:upper	

Name	con:disp:split:lower	
Description	Turns on the split window function and sweeps the bottom window.	
Syntax	Con:disp:split:lower	

Name	con:disp:split:alt	
Description	Sweeps the upper and lower windows alternatively in the split window mode.	
Syntax	Con:disp:split:lower	

Name	con:disp:split:full	
Description	Returns the spectrum analyser to single window mode. The upper window is used as the active window.	
Syntax	Con:disp:split:full	



4.3.12 Preset Commands

Name	con:preset
Description	Loads the factory default settings. This is the equivalent to pressing the Preset key.
Syntax	con:preset

4.3.13 System Commands

Name	con:sys:ser?	
Description	Returns the serial number.	
Query syntax	con:sys:ser?	
Return parameter	<string>	Returns the serial number in the following format: XXXXXXXX
Example	Con:sys:ser? >XXXXXXXX	



5 FAQ

- ▶ **I connected the signal but it does not appear on screen.**
- ▶ **The trace is updated too slowly.**
- ▶ **I cannot see the trace on the screen.**
- ▶ **The performance does not match the specification.**

- I connected the signal but it does not appear on screen.

Run Autoset and let the **AE-366B** find the best display scale for your target signal. Press the Autoset key, then press Autoset .

- The trace is updated too slowly on the screen.

The sweep time determines how often the trace is updated on the screen. To increase the sweep time, try reducing the span or using a wider RBW setting.

- I cannot see the trace on the screen.

If you cannot see the trace on the screen, there may be a number of possibilities.

1 The trace is just off screen: Try to adjust the reference level with the amplitude key.

2 The trace may be in the "Blank" mode: Putting the trace into view mode will enable the trace to be viewed again.

- The performance does not match the specification.

Make sure the device is powered On for at least 30 minutes, within +20 °C ~ +30 °C. This is necessary to stabilize the unit to match the specification.



6 SPECIFICATIONS

6.1 Specifications AE-366B

FREQUENCY

Frequency Range

Setting Range 150 kHz to 3 GHz.

Center Frequency

Setting Resolution 0.1 MHz.

Accuracy within ± 50 kHz
(frequency span: 0.3 GHz to 2.6 GHz, 20 ± 5 °C).

Frequency Span

Setting Range 1 MHz to 3 GHz.

Accuracy within $\pm 3\%$
(frequency span: 0.3 GHz to 2.6 GHz, 20 ± 5 °C).

Resolution Bandwidth

Setting Range 30 kHz, 100 kHz, 300 kHz, 1 MHz.

SSB Phase Noise

-85 dBc/Hz (typical, 500 kHz offset, RBW: 30 kHz, Sweep time: 1.5s, Span: 1MHz@1GHz)

Inherent Spurious Response

less than -45 dBc @ -40 dBm Ref. Level (typical less than -50 dBc).

AMPLITUDE

Reference Level

Input Range $+20$ to -40 dBm.

Unit dBm, dBV, dB μ V.

Average Noise Level

≤ -100 dBm.
(typical, center frequency: 1 GHz RBW: 30 kHz)

Frequency Characteristic

within ± 3.0 dB @ 300MHz ~ 2.6 GHz
within ± 6.0 dB @ 80 ~ 300 MHz, 2.6 ~ 3 GHz.

Accuracy within ± 2 dB (1 GHz); SPAN: 5 MHz; Ref. Level odBm, input signal -10 dBm.

Input

Input impedance 50 Ω .

Input VSWR less than 2.0@input att ≥ 10 dB.

Input damage level $+30$ dBm (CW average power), 25 VDC.

Input connector N connector.



SWEEP

Sweep Time

Setting Range	300 ms to 8.4 s, auto (not adjustable).
Accuracy	within $\pm 2\%$ (frequency span: full span).

GENERAL

Communication

Display	640 x 480 RGB color LCD.
----------------	--------------------------

Interface

RS-232C	Sub-D female-D 9 pins
USB Connector	USB Host/Device full speed supported.
USB Format	Supports FAT/FAT32 only.

VGA Output	Sub-D female 15 pins.
-------------------	-----------------------

Power Source	AC 100-240V, 50/60 Hz.
---------------------	------------------------

OPERATING ENVIRONMENTAL CONDITIONS

Operating Temperature	From 5 to 45 °C (Guaranteed at 25 $\pm 5^{\circ}\text{C}$, without soft carrying case).
Operating Humidity	Less than 45 °C / 90 % RH.
Storage Temperature	-20 to 60 °C, less than 60 °C / 70 % RH.

MECHANICAL FEATURES

Dimensions	115.1 (W) x 152 (H) x 296 (L) mm.
Weight	2.2 kg

INCLUDED ACCESSORIES

1 x DG0140	Quick Reference Guide.
1 x AD059	"N"/M - BNC/H Adapter.
1 x	Power Cord.

RECOMMENDATIONS ABOUT THE PACKING

It is recommended to keep all the packing material in order to return the equipment, if necessary, to the Technical Service.



6.2 Default Settings

- ▶ **Frequency**
 - **Center Frequency:** 1.5GHz
 - **Start Frequency:** 0Hz
 - **Stop Frequency:** 3GHz
 - **CF Step:** Auto

- ▶ **Span**
 - **Span:** 3GHz

- ▶ **Amplitude**
 - **Reference level:** -30.0dBm
 - **Scale Div:** 10
 - **Units:** dBm

- ▶ **Autoset**
 - **Amp.Floor:** Auto
 - **Span:** Auto

- ▶ **Marker**
 - **Marker:** Off

- ▶ **Peak Search**
 - **N/A**

- ▶ **Meas**
 - **ACPR:** Off
 - **OCBW:** Off

- ▶ **Limit Line**
 - **H Limit:** Off
 - **L Limit:** Off
 - **Pass/Fail:** Off

- ▶ **BW**
 - **RBW:** Auto



- ▶ **Trace**
 - **Trace:** A: Clear&Write
 - **Average:** Off

- ▶ **Display**
 - **Full Display:** Active
 - **Display line:** off

- ▶ **Memory**
 - N/A

- ▶ **Preset**
 - N/A

- ▶ **Hardcopy**
 - N/A

- ▶ **Hardcopy Setup**
 - **Ink Normal**

- ▶ **System**
 - N/A